

# Lecture Notes on Nonlinear Vibrations

Richard H. Rand

Dept. Theoretical & Applied Mechanics  
Cornell University  
Ithaca NY 14853  
rhr2@cornell.edu

<http://www.tam.cornell.edu/randdocs/>

version 46

Copyright 2005 by Richard H. Rand

# Contents

<b>1</b>	<b>Phase Plane</b>	<b>4</b>
1.1	Classification of Linear Systems . . . . .	4
1.2	Lyapunov Stability . . . . .	5
1.3	Structural Stability . . . . .	7
1.4	Examples . . . . .	8
1.5	Problems . . . . .	8
1.6	Appendix: Lyapunov's Direct Method . . . . .	10
<b>2</b>	<b>The Duffing Oscillator</b>	<b>13</b>
2.1	Lindstedt's Method . . . . .	14
2.2	Elliptic Functions . . . . .	15
2.3	Problems . . . . .	17
<b>3</b>	<b>The van der Pol Oscillator</b>	<b>19</b>
3.1	The Method of Averaging . . . . .	19
3.2	Hopf Bifurcations . . . . .	23
3.3	Homoclinic Bifurcations . . . . .	24
3.4	Relaxation Oscillations . . . . .	27
3.5	The van der Pol oscillator at Infinity . . . . .	29
3.6	Example . . . . .	32
3.7	Problems . . . . .	32
<b>4</b>	<b>The Forced Duffing Oscillator</b>	<b>34</b>
4.1	Two Variable Expansion Method . . . . .	35
4.2	Cusp Catastrophe . . . . .	38
4.3	Problems . . . . .	39
<b>5</b>	<b>The Forced van der Pol Oscillator</b>	<b>40</b>
5.1	Entrainment . . . . .	40
5.2	Problems . . . . .	44
<b>6</b>	<b>Mathieu's Equation</b>	<b>45</b>
6.1	Perturbations . . . . .	46
6.2	Floquet Theory . . . . .	47
6.3	Hill's Equation . . . . .	49
6.4	Harmonic Balance . . . . .	51
6.5	Effect of Damping . . . . .	53
6.6	Effect of Nonlinearity . . . . .	54
6.7	Problems . . . . .	56
<b>7</b>	<b>Ince's Equation</b>	<b>59</b>
7.1	Coexistence . . . . .	60
7.2	Ince's Equation . . . . .	61
7.3	Designing a System with a Finite Number of Tongues . . . . .	64

7.4	Application 1 . . . . .	65
7.5	Application 2 . . . . .	65
7.6	Application 3 . . . . .	66
7.7	Problems . . . . .	68
<b>8</b>	<b>Two Coupled Conservative Oscillators</b>	<b>71</b>
8.1	Nonlinear Normal Modes . . . . .	71
8.2	The Modal Equation . . . . .	73
8.3	Problems . . . . .	75
<b>9</b>	<b>Two Coupled Limit Cycle Oscillators</b>	<b>76</b>
9.1	Two Coupled van der Pol Oscillators . . . . .	76
<b>10</b>	<b>Center Manifolds</b>	<b>81</b>
10.1	Example . . . . .	81
10.2	Problems . . . . .	84
<b>11</b>	<b>N Coupled Limit Cycle Oscillators</b>	<b>85</b>
11.1	Two Phase-Only Oscillators . . . . .	85
11.2	N Phase-Only Oscillators . . . . .	87
11.3	Problems . . . . .	89
<b>12</b>	<b>Continuum of Coupled Conservative Oscillators</b>	<b>90</b>
12.1	Derivation . . . . .	90
12.2	Traveling Wave Solution . . . . .	91
<b>13</b>	<b>Melnikov's Method for Predicting Chaos</b>	<b>93</b>
13.1	Example . . . . .	94
13.2	Problems . . . . .	96
<b>14</b>	<b>Differential-Delay Equations</b>	<b>97</b>
14.1	Stability of Equilibrium . . . . .	97
14.2	Lindstedt's Method . . . . .	98
14.3	Center Manifold Analysis . . . . .	100
14.4	Problems . . . . .	109

# 1 Phase Plane

The differential equation describing many nonlinear oscillators can be written in the form:

$$\frac{d^2x}{dt^2} + f\left(x, \frac{dx}{dt}\right) = 0 \quad (1)$$

A convenient way to treat eq.(1) is to rewrite it as a system of two first order o.d.e.'s:

$$\frac{dx}{dt} = y, \quad \frac{dy}{dt} = -f(x, y) \quad (2)$$

Eqs.(2) may be generalized in the form:

$$\frac{dx}{dt} = F(x, y), \quad \frac{dy}{dt} = G(x, y) \quad (3)$$

A point which satisfies  $F(x, y) = 0$  and  $G(x, y) = 0$  is called an *equilibrium point*. The solution to (3) may be pictured as a curve in the  $x$ - $y$  *phase plane* passing through the point of initial conditions  $(x_0, y_0)$ . Each time a motion passes through a given point  $(x, y)$ , its direction is always the same. This means a given motion may not intersect itself. A periodic motion corresponds to a closed curve in the  $x$ - $y$  plane. In the special case that the first equation of (3) is  $dx/dt = y$ , as in the case of eqs.(2), the motion in the upper half-plane  $y > 0$  must proceed to the right, that is,  $x$  must increase in time for  $y > 0$ , and vice versa for  $y < 0$ .

## 1.1 Classification of Linear Systems

An important special case of the general system (3) is the general linear system:

$$\frac{dx}{dt} = a x + b y, \quad \frac{dy}{dt} = c x + d y \quad (4)$$

We may seek a solution to eqs.(4) by setting  $x(t) = A \exp(\lambda t)$  and  $y(t) = B \exp(\lambda t)$ . For a nontrivial solution, the following determinant must vanish:

$$\begin{vmatrix} a - \lambda & b \\ c & d - \lambda \end{vmatrix} = 0 \quad \Rightarrow \quad \lambda^2 - \text{tr } \lambda + \det = 0 \quad (5)$$

where  $\text{tr} = a + d$  is the trace, and  $\det = ad - bc$  is the determinant of the associated matrix. The eigenvalue  $\lambda$  is given by

$$\lambda = \frac{\text{tr}}{2} \pm \sqrt{\left(\frac{\text{tr}}{2}\right)^2 - \det} \quad (6)$$

If  $\det < 0$ , then (6) shows that there are two real eigenvalues, one positive and one negative. This type of linear system is called a *saddle*. An example of a saddle is provided by the equation:

$$\frac{d^2x}{dt^2} - x = 0 \quad (7)$$

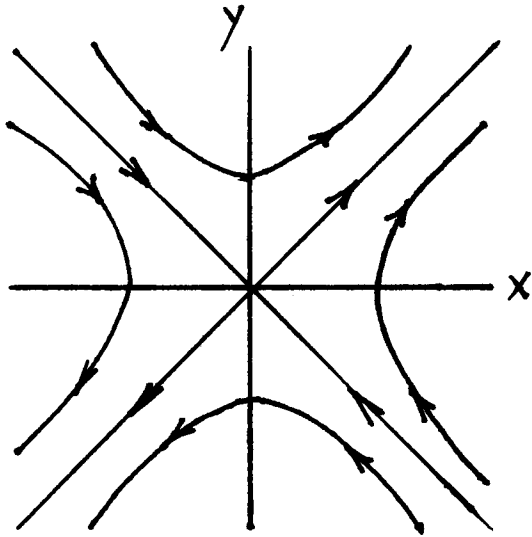

$\ddot{x} - x = 0$   
Saddle

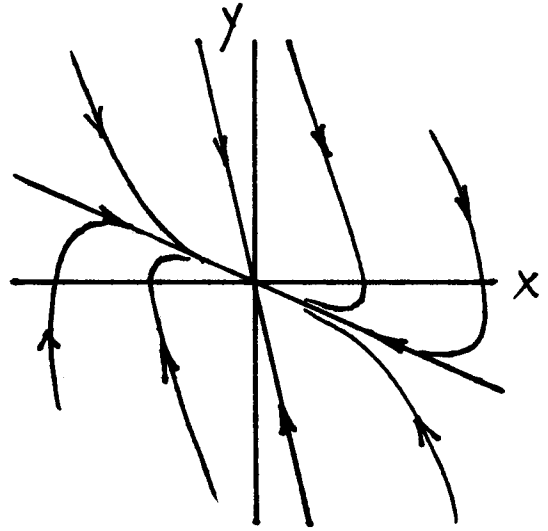

$\ddot{x} + 3\dot{x} + x = 0$   
stable node

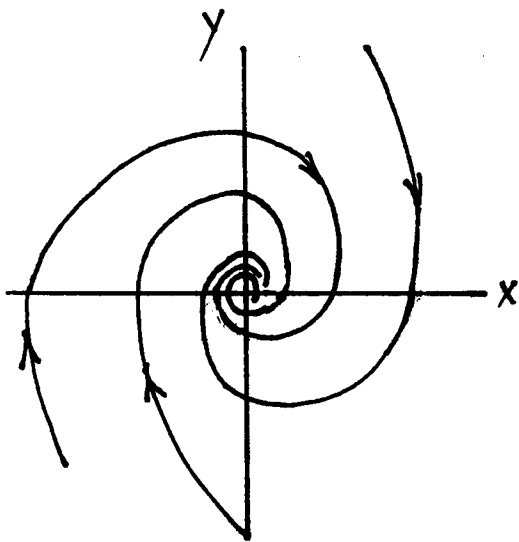

$\ddot{x} + \dot{x} + x = 0$   
stable spiral

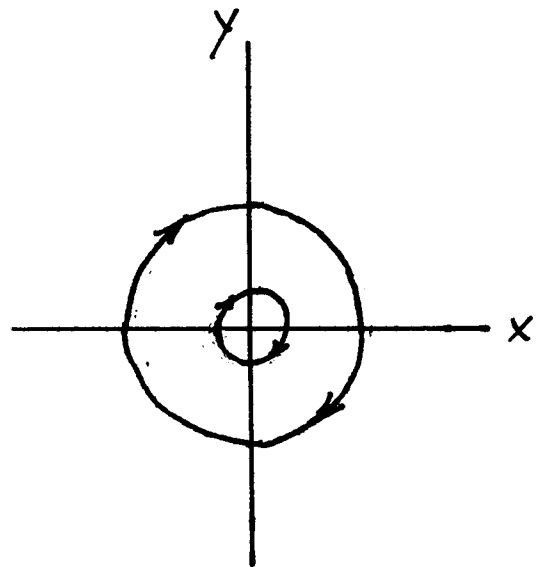

$\ddot{x} + x = 0$   
center

If  $\det > 0$  and  $\text{tr}^2 > 4 \det$ , then there are still two real eigenvalues, but both have the same sign as the trace  $\text{tr}$ . If  $\text{tr} > 0$ , then both eigenvalues are positive and the solution becomes unbounded as  $t$  goes to infinity. This linear system is called an *unstable node*. The general solution is a linear combination of the two eigensolutions, and for large time the eigensolution corresponding to the larger eigenvalue dominates. Similarly, if the trace  $\text{tr} < 0$ , we have a *stable node*. An example of a stable node is provided by the overdamped oscillator:

$$\frac{d^2x}{dt^2} + 3\frac{dx}{dt} + x = 0 \quad (8)$$

If  $\det > 0$  and  $\text{tr}^2 < 4 \det$ , then there are two complex eigenvalues with real part equal to  $\text{tr}/2$ . Euler's formula shows us that the resulting motion will involve an oscillation as well as exponential growth or decay. If the trace  $\text{tr} > 0$  we have unbounded growth and the linear system is called an *unstable spiral* or *focus*. Similarly, if the trace  $\text{tr} < 0$ , we have a *stable spiral* or *focus*. An example of a stable spiral is provided by the underdamped oscillator:

$$\frac{d^2x}{dt^2} + \frac{dx}{dt} + x = 0 \quad (9)$$

If  $\det > 0$  and  $\text{tr} = 0$ , then there are two pure imaginary eigenvalues. The corresponding linear system is called a *center*. An example of a center is provided by the simple harmonic oscillator:

$$\frac{d^2x}{dt^2} + x = 0 \quad (10)$$

All the foregoing results can be summarized in a diagram in which the determinant  $\det$  is plotted on the horizontal axis, while the trace  $\text{tr}$  is plotted on the vertical axis.

## 1.2 Lyapunov Stability

Suppose that we have an equilibrium point  $P : (x_0, y_0)$  in eqs.(3). And suppose further that we want to characterize the nature of the behavior of the system in the neighborhood of point  $P$ . A tempting way to proceed would be to Taylor-expand  $F$  and  $G$  about  $(x_0, y_0)$  and truncate the series at the linear terms. The motivation for such a move is that near the equilibrium point, the quadratic and higher order terms are much smaller than the linear terms, and so they can be neglected. A convenient way to do this is to define two new coordinates  $\xi$  and  $\eta$  such that

$$\xi = x - x_0, \quad \eta = y - y_0 \quad (11)$$

Then we obtain

$$\frac{d\xi}{dt} = \frac{\partial F}{\partial x}\xi + \frac{\partial F}{\partial y}\eta + \dots, \quad \frac{d\eta}{dt} = \frac{\partial G}{\partial x}\xi + \frac{\partial G}{\partial y}\eta + \dots \quad (12)$$

where the partial derivatives are evaluated at point  $P$  and where we have used the fact that  $F$  and  $G$  vanish at  $P$  since it is an equilibrium point. The eqs.(12) are known as the *linear variational equations*.

Now if we were satisfied with the linear approximation given by (12), we could apply the classification system described in the previous section, and we could identify a given equilibrium point

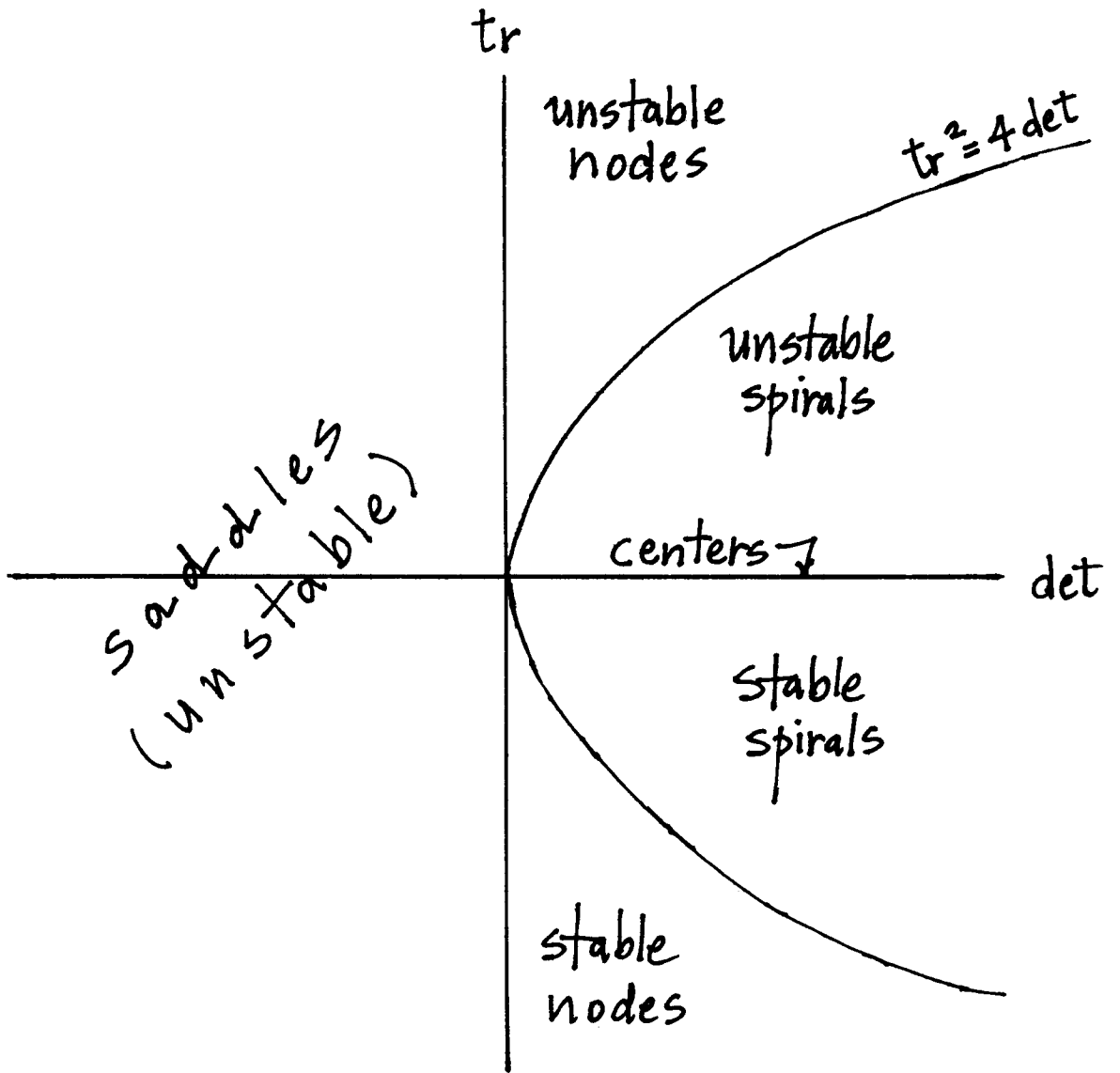

as a saddle or a center or a stable node, etc. This sounds like a good idea, but there is a problem with it: How can we be assured that the nonlinear terms which we have truncated do not play a significant role in determining the local behavior?

As an example of the sort of thing that can go wrong, consider the system:

$$\frac{d^2x}{dt^2} - \epsilon \left( \frac{dx}{dt} \right)^3 + x = 0, \quad \epsilon > 0 \quad (13)$$

This system has an equilibrium point at the origin  $x=dx/dt=0$ . If linearized in the neighborhood of the origin, (13) is a center, and as such exhibits bounded solutions. The addition of the nonlinear negative damping term will, however, cause the system to exhibit unbounded motions. Thus the addition of a nonlinear term has completely changed the qualitative nature of the predictions based on the linear variational equations.

In order to use the linear variational equations to characterize an equilibrium point, we need to know when they can be trusted, that is, we need sufficient conditions which will guarantee that the sort of thing that happened in eq.(13) won't happen. In order to state the correct conditions we need a couple of definitions:

Definition: A motion  $M$  is said to be *Lyapunov stable* if given any  $\epsilon > 0$ , there exists a  $\delta > 0$  such that if  $N$  is any motion which starts out at  $t=0$  inside a  $\delta$ -ball centered at  $M$ , then it stays in an  $\epsilon$ -ball centered at  $M$  for all time  $t$ .

In particular this means that an equilibrium point  $P$  will be Lyapunov stable if you can choose the initial conditions sufficiently close to  $P$  (inside a  $\delta$ -ball) so as to be able to keep all the ensuing motions inside an arbitrarily small neighborhood of  $P$  (inside an  $\epsilon$ -ball). A motion is said to be Lyapunov unstable if it is not Lyapunov stable.

Definition: If in addition to being Lyapunov stable, all motions  $N$  which start out at  $t = 0$  inside a  $\delta$ -ball centered at  $M$  (for some  $\delta$ ), approach  $M$  asymptotically as  $t \rightarrow \infty$ , then  $M$  is said to be *asymptotically Lyapunov stable*.

Lyapunov's theorems:

1. An equilibrium point in a nonlinear system is asymptotically Lyapunov stable if all the eigenvalues of the linear variational equations have negative real parts.
2. An equilibrium point in a nonlinear system is Lyapunov unstable if there exists at least one eigenvalue of the linear variational equations which has a positive real part.

Definition: An equilibrium point is said to be *hyperbolic* if all the eigenvalues of its linear variational equations have non-zero real parts.

Note that a center is not hyperbolic. Also, from eq.(6), any linear system which has  $\det = 0$  is not hyperbolic.



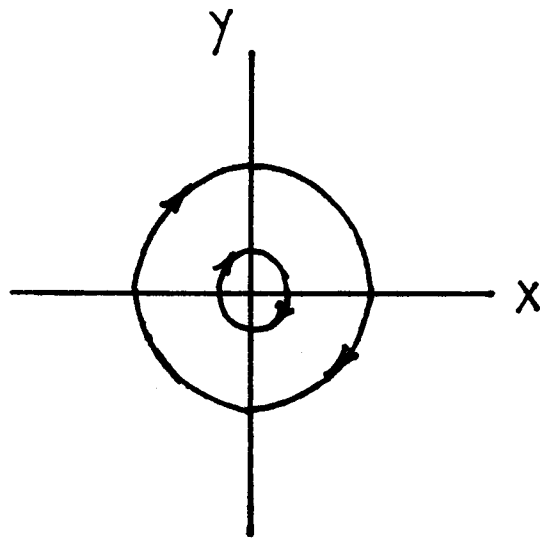

$$\ddot{x} + x = 0$$

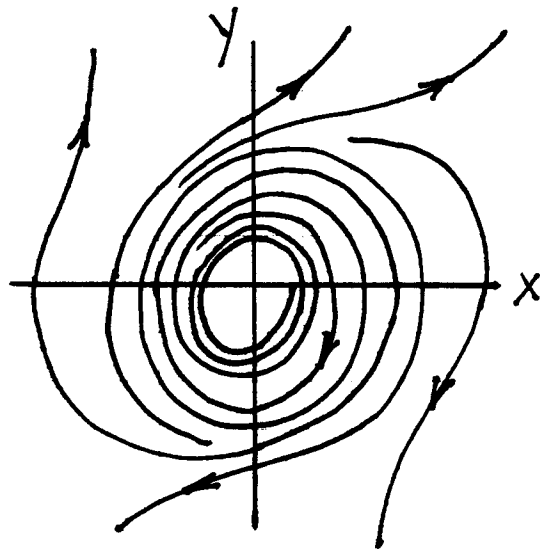

$$\ddot{x} - \varepsilon \dot{x}^3 + x = 0, \quad \varepsilon > 0$$

Thus Lyapunov's theorems state that if the equilibrium is hyperbolic then the linear variational equations correctly predict the Lyapunov stability in the nonlinear system. (Note that in the second of Lyapunov's theorems, it is not *necessary* for the equilibrium to be hyperbolic since the presence of an eigenvalue with positive real part implies instability even if it is accompanied by other eigenvalues with zero real part.)

### 1.3 Structural Stability

If an equilibrium point is hyperbolic, then we saw that the linear variational equations correctly represent the nonlinear system locally, as far as Lyapunov stability goes. But more can be said. For a hyperbolic equilibrium point, the *topology* of the linearized system is the same as the topology of the nonlinear system in some neighborhood of the equilibrium point. Specifically, for a hyperbolic equilibrium point  $P$ , there is a continuous 1:1 invertible transformation (a *homeomorphism*) defined on some neighborhood of  $P$  which maps the motions of the nonlinear system to the motions of the linearized system. This is called Hartman's theorem.

A related idea is that of *structural stability*. This idea concerns the relationship between the dynamics of a given dynamical system, say for example eqs.(3), and the dynamics of a neighboring system, for example:

$$\frac{dx}{dt} = F(x, y) + \epsilon F_1(x, y), \quad \frac{dy}{dt} = G(x, y) + \epsilon G_1(x, y) \quad (14)$$

where  $\epsilon$  is a small quantity and where  $F_1$  and  $G_1$  are continuous. A system  $S$  is said to be structurally stable if all nearby systems are topologically equivalent to  $S$ . Specifically, eqs.(3) are structurally stable if there exists a homeomorphism taking motions of (3) to motions of (14) for some  $\epsilon$ .

Note the similarity between Lyapunov stability and structural stability: Both involve a given dynamical object, and both are concerned with the effects of a perturbation off of that object. For example in the case of Lyapunov stability, the object could be the equilibrium point  $x=dx/dt=0$  in eq.(13), and the perturbation could be a nearby initial condition. In the case of structural stability, the object could be the simple harmonic oscillator (10), and the perturbation could be the addition of a small term such as  $-\epsilon(dx/dt)^3$ , giving eq.(13).

From this example, we can see that if a system  $S$  has an equilibrium point which is *not* hyperbolic, then  $S$  is not structurally stable. Another common feature which can prevent a system from being structurally stable is the presence of a saddle-saddle connection. In fact it is possible to characterize all structurally stable flows on the phase plane. To do so, we need another

Definition: A point is said to be *wandering* if it has some neighborhood which leaves and never (as  $t \rightarrow \infty$ ) returns to intersect its original position.

Now it is possible to state Peixoto's theorem for flows on the plane which are closed and bounded (that is, which are *compact*). Such a system is structurally stable if and only if:

1. the number of equilibrium points and periodic motions is finite, and each one is hyperbolic;

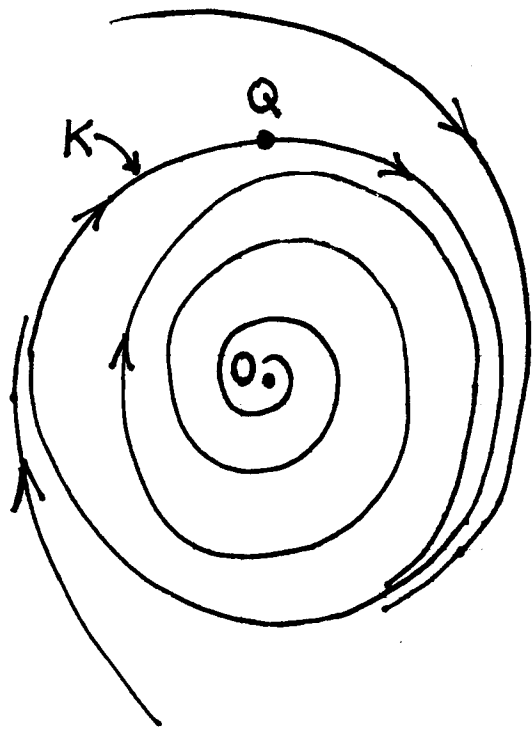

The nonwandering set consists of

$$\{0, Q, k\}$$

The system is structurally unstable.

2. there are no saddle-saddle connections; and
3. the set of nonwandering points consists only of equilibrium points and periodic motions.

## 1.4 Examples

### Example 1.1

The plane pendulum.

$$\frac{d^2x}{dt^2} + \frac{g}{L} \sin x = 0 \quad (15)$$

Equilibria:  $y = 0$ ,  $x = 0, \pi$

By identifying  $x = \pi$  with  $x = -\pi$  we see that the topology of the phase space is a cylinder  $S \times R$ .

First integral:  $\frac{y^2}{2} - \frac{g}{L} \cos x = \text{constant}$

### Example 1.2

Pendulum in a plane which is rotating about a vertical axis with angular speed  $\omega$ .

$$\frac{d^2x}{dt^2} + \frac{g}{L} \sin x - \omega^2 \sin x \cos x = 0 \quad (16)$$

Equilibria:  $y = 0$ ,  $x = 0, \pi$  and also  $\cos x = \frac{g}{\omega^2 L}$

For real roots,  $\frac{g}{\omega^2 L} < 1$ , illustrating a *pitchfork bifurcation*.

First integral:  $\frac{y^2}{2} - \frac{g}{L} \cos x + \frac{\omega^2}{4} \cos 2x = \text{constant}$

### Example 1.3

Pendulum with constant torque  $T$ .

$$\frac{d^2x}{dt^2} + \frac{g}{L} \sin x = \frac{T}{mL^2} \quad (17)$$

Equilibria:  $\sin x = \frac{T}{mgL}$

For real roots,  $\frac{T}{mgL} < 1$ , illustrating a *fold or saddle-node bifurcation*.

First integral:  $\frac{y^2}{2} - \frac{g}{L} \cos x - \frac{T}{mL^2} x = \text{constant}$

## 1.5 Problems

### Problem 1.1

Volterra's predator-prey equations. We imagine a lake environment in which a certain species of fish (prey) eats only plankton, which is assumed to be present in unlimited quantities. Also present is a second species of fish (predators) which eats only the first species. Let  $x$ =number of prey and let  $y$ =number of predators. The model assumes that in the absence of interactions, the prey grow without bound and the predators starve:

# Plane Pendulum

$$\ddot{x} + \sin x = 0$$



$$\uparrow y = \dot{x}$$

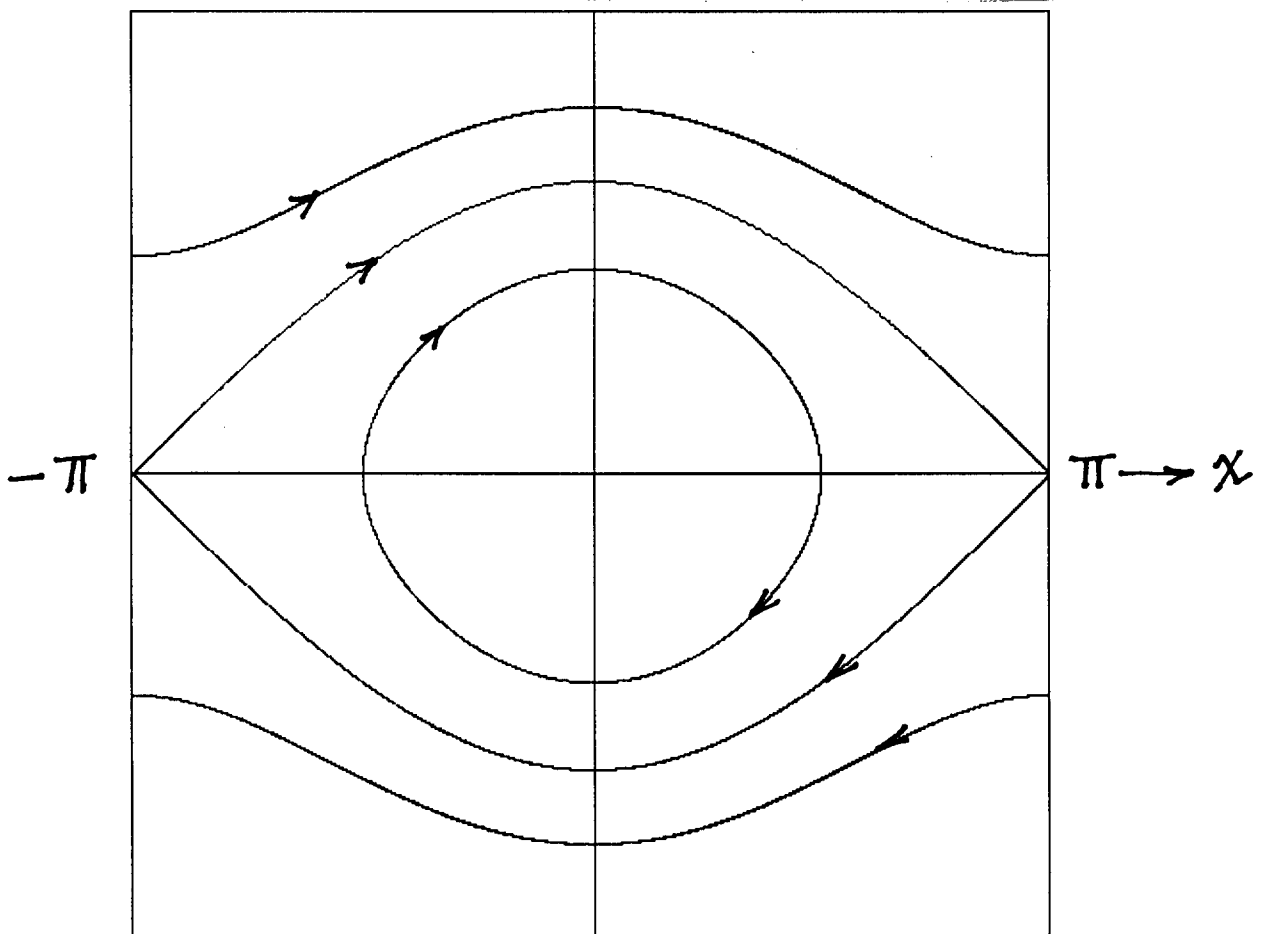

# Pendulum in a Rotating Plane

$$\ddot{x} + \sin x - \omega^2 \sin x \cos x = 0$$

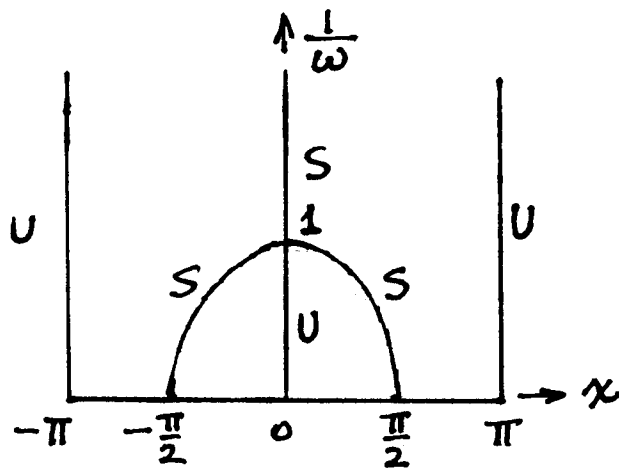
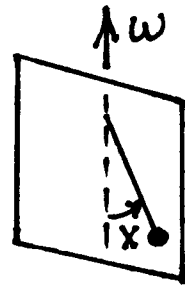

U = unstable  
S = stable

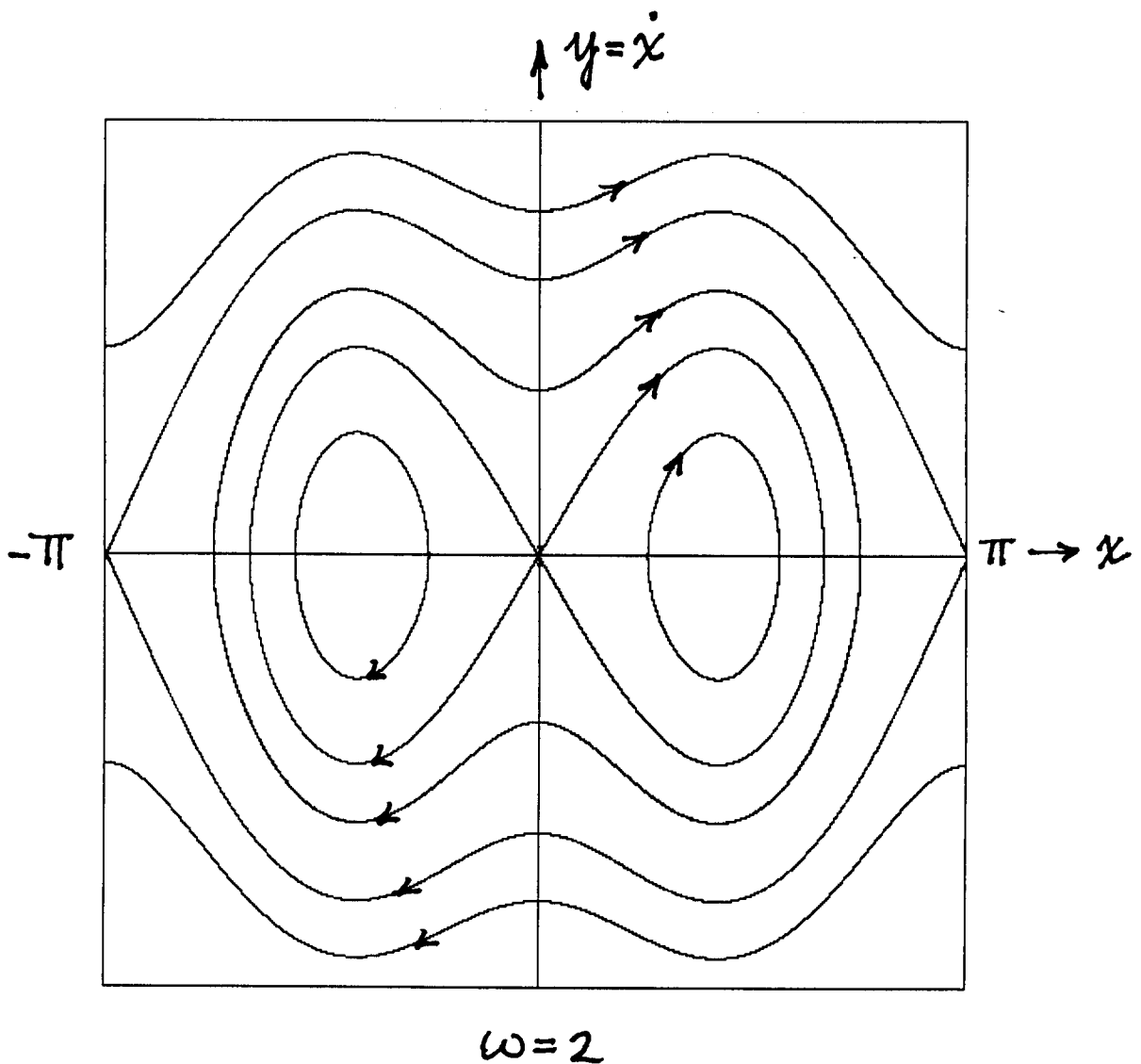

# Pendulum with Constant Torque

$$\ddot{x} + \sin x = T$$

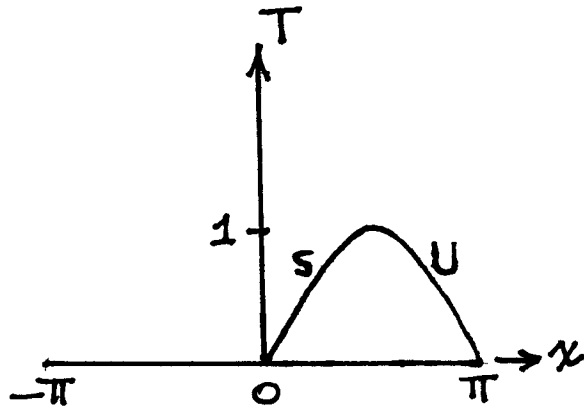
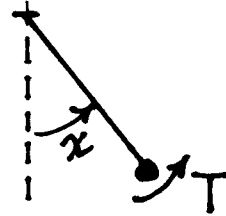

$$\uparrow y = \dot{x}$$

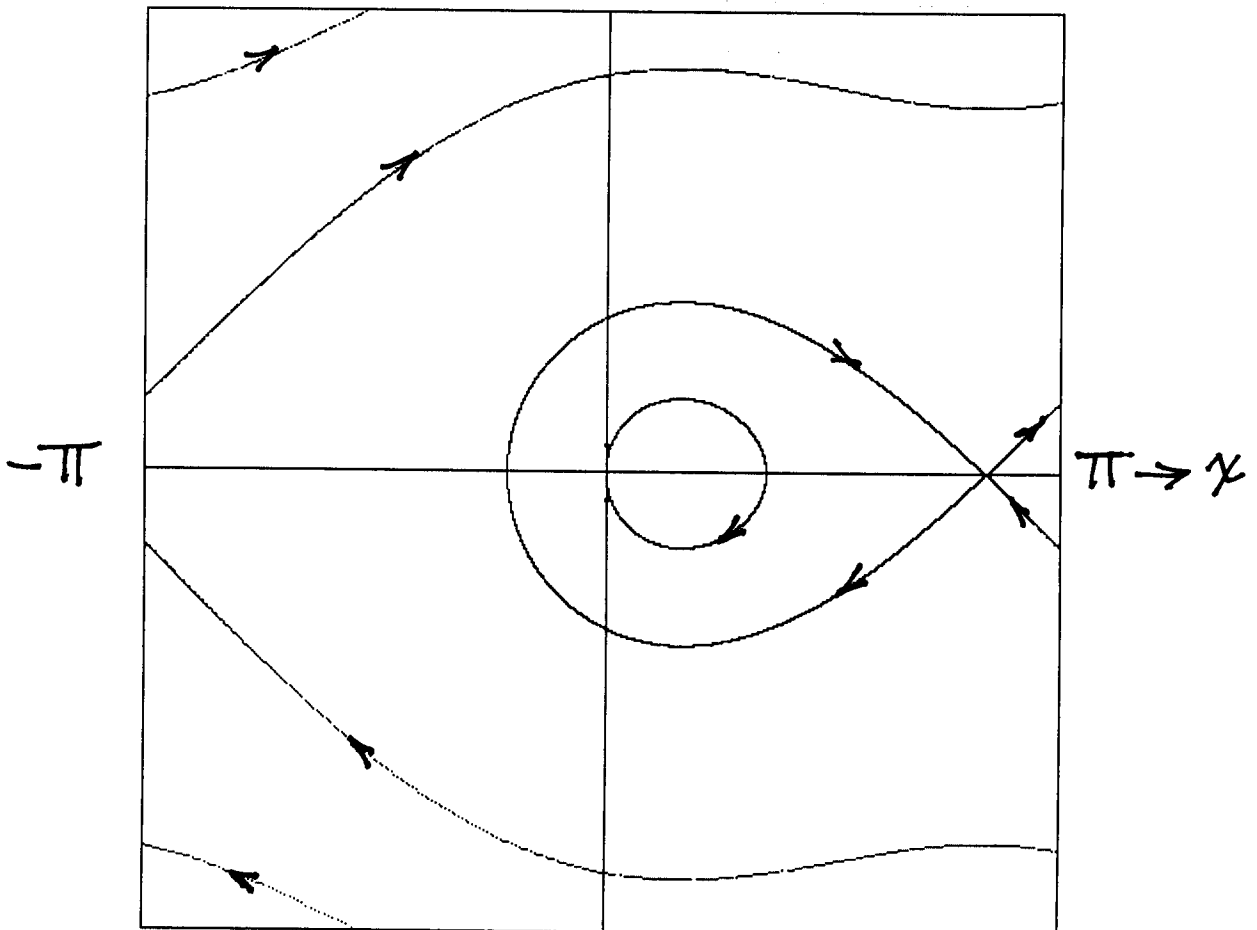

$$T = \frac{1}{2}$$

$$\frac{dx}{dt} = ax, \quad \frac{dy}{dt} = -by \quad (18)$$

As a result of interactions, the prey decrease in number, while the predators increase. The number of interactions is modeled as  $xy$ . The final model becomes:

$$\frac{dx}{dt} = ax - cxy, \quad \frac{dy}{dt} = -by + dxy \quad (19)$$

where parameters  $a, b, c, d$  are positive.

- Find any equilibria that this system possesses, and for each one, determine it's type.
- Using  $\frac{dy}{dx} = \frac{dy}{dt} \div \frac{dx}{dt}$ , obtain an exact expression for the integral curves.
- Sketch the trajectories in the phase plane.
- Is this system structurally stable? Explain your answer.

### Problem 1.2

Zhukovskii's model of a glider. Imagine a glider operating in a vertical plane. Let  $v$ =speed of glider and  $u$ =angle flight path makes with the horizontal. In the absence of drag (friction), the dimensionless equations of motion are:

$$\frac{dv}{dt} = -\sin u, \quad v \frac{du}{dt} = -\cos u + v^2 \quad (20)$$

- Using numerical integration, sketch the trajectories on a slice of the  $u$ - $v$  phase plane between  $-\pi < u < \pi$ ,  $v > 0$ .
- Using  $\frac{dv}{du} = \frac{dv}{dt} \div \frac{du}{dt}$ , obtain an exact expression for the integral curves.
- Using your result in part b, obtain an exact expression for the separatrix in this system.
- What does the flight path of the glider look like for motions inside the separatrix versus motions outside the separatrix? Sketch the glider's flight path in both cases.

### Problem 1.3

Malkin's error. In his book "Theory of Stability of Motion" (1952), I.G. Malkin presents an example of a physical problem in which the linear variational equations do not predict stability correctly. His analysis is restated below for your convenience. In fact, there is a mistake in his argument. Your job is to find it.

The periodic motions of a pendulum are certainly Lyapunov unstable (since the period of perturbed motions differs from the period of the unperturbed motion, etc.) However, the linearized equations predict stability:

The governing equation is  $\frac{d^2\theta}{dt^2} + \sin \theta = 0$ . A periodic solution  $\theta = f(t)$  will correspond to the initial condition  $\theta(0) = f(0) = \alpha$ ,  $\frac{d\theta}{dt}(0) = \frac{df}{dt}(0) = 0$ . (The pendulum is released from rest at an



# THEORY OF STABILITY OF MOTION

By  
I. G. Malkin

As a second example let us consider the oscillations of a mathematical pendulum. As an undisturbed motion let us take an oscillation defined by the initial conditions  $\varphi(0) = \alpha$ ,  $\dot{\varphi}(0) = 0$ , where  $\varphi$  is the angle of deviation of the pendulum. The differential equation of the disturbed motion, as we saw in Par. 3 has the form (3.6). Rejecting the terms of higher orders, we shall have an equation of the first approximation:

$$\frac{d^2x}{dt^2} = -\frac{g}{l} x \cos f(t). \quad (5.7)$$

Let us consider the disturbed motion defined by the initial conditions  $x(0) = 0$ ,  $\dot{x}(0) = \beta$ . The period of disturbed oscillations differs from the period of undisturbed oscillations, and therefore, as we have seen in Par. 3 there arrives a moment when the difference in the value of  $\varphi$  in both oscillations will exceed a certain quantity independent of  $\beta$ , no matter how small  $\beta$  may be. We shall show however that if this difference in values of  $\varphi$ , that is, the magnitude  $x$ , is determined by the equation of the first approximation of (5.7), then for a sufficiently small value of  $\beta$  it will remain smaller than any preassigned quantity.

Indeed, substituting the function  $f(t)$  in equation (3.5) which it satisfies, and differentiating the resulting identity with respect to small  $t$ , we shall have

$$\frac{d^2}{dt^2} \left( \frac{df}{dt} \right) = -\frac{g}{l} \frac{df}{dt} \cos f.$$

Consequently, the function  $x = \frac{df}{dt}$  satisfies the equation (5.7). Since at the same time function  $f(t)$  satisfies the initial conditions  $f(0) = \alpha$ ,  $\left( \frac{df}{dt} \right)_0 = 0$ , then the function  $\frac{df}{dt}$  will satisfy the initial conditions  $\left( \frac{df}{dt} \right)_0 = 0$ ,  $\left( \frac{d^2f}{dt^2} \right)_0 = -\frac{g}{l} \sin \alpha$ . Consequently, the desired solution of equation (5.6) has the form

$$x = -\frac{l \beta}{g \sin \alpha} \frac{df(t)}{dt}.$$

From this we conclude, taking into account the fact that  $\frac{df}{dt}$  is a limited function, the magnitude  $x$  will remain smaller than any preassigned quantity  $\varepsilon$ , if the quantity  $\beta$  is sufficiently small. Therefore, in the example considered the first approximation gives an incorrect description of the character of motion.

angle  $\alpha$ .) Note that  $\frac{d^2 f}{dt^2}(0) = -\sin f(0) = -\sin \alpha$ .

Consider the linearized stability of  $\theta = f(t)$ . Set  $\theta = f(t) + x(t)$  and linearize the eq. on  $x$  to get  $\frac{d^2 x}{dt^2} + x \cos f(t) = 0$ . Consider the perturbed motion defined by the initial condition  $x(0) = 0$ ,  $\frac{dx}{dt}(0) = \beta$ . Malkin shows that “for a sufficiently small value of  $\beta$  it [i.e.  $x(t)$ ] will remain smaller than any preassigned quantity.”

Since  $f(t)$  satisfies  $\frac{d^2 f}{dt^2} + \sin f = 0$ ,  $f(t)$  satisfies (differentiating)  $\frac{d^2}{dt^2}(\frac{df}{dt}) + \frac{df}{dt} \cos f = 0$ . But this equation on  $\frac{df}{dt}(t)$  has the same form as the linearized equation on  $x(t)$ . Since the function  $\frac{df}{dt}(t)$  satisfies the initial conditions  $\frac{df}{dt}(0) = 0$ ,  $\frac{d}{dt}(\frac{df}{dt})(0) = \frac{d^2 f}{dt^2}(0) = -\sin \alpha$ , it follows from uniqueness that  $x(t) = -\frac{\beta}{\sin \alpha} \frac{df}{dt}(t)$ . Now since  $\frac{df}{dt}(t)$  is bounded,  $x(t)$  can be made as small as desired for all  $t$  by choosing  $\beta$  small enough. Ha!

## 1.6 Appendix: Lyapunov’s Direct Method

Lyapunov’s Direct Method offers a procedure for investigating the stability of an equilibrium point without first linearizing the differential equations in the neighborhood of the equilibrium. Using this approach, Lyapunov was able to prove the validity of the linear variational equations.

As an introduction to the method, consider the simple example:

$$\frac{dx_1}{dt} = -x_1, \quad \frac{dx_2}{dt} = -x_2 \quad (21)$$

It is obvious that the origin in this system is an asymptotically stable equilibrium point since we know the general solution,

$$x_1 = c_1 \exp(-t), \quad x_2 = c_2 \exp(-t) \quad (22)$$

Ignoring this knowledge, consider the function:

$$V(x_1, x_2) = x_1^2 + x_2^2 \quad (23)$$

being the square of the distance from the origin in the  $x_1$ - $x_2$  phase plane. Now consider the derivative of  $V$  with respect to time  $t$ :

$$\frac{dV}{dt} = 2x_1 \frac{dx_1}{dt} + 2x_2 \frac{dx_2}{dt} \quad (24)$$

Substituting eqs.(21), we see that along the trajectories of the system,

$$\frac{dV}{dt} = -2x_1^2 - 2x_2^2 \leq 0 \quad (25)$$

Thus  $V$  must decrease as a function of time  $t$ , that is, the distance of a point on a trajectory from the origin must decrease in time. Since there is no place at which such a point can get stuck (since  $dV/dt = 0$  only at the origin), we have shown that all solutions must approach the

origin as  $t \rightarrow \infty$ , which is to say that the origin is asymptotically stable.

The approach in this example can be generalized by inventing an appropriate Lyapunov function  $V(x_1, x_2)$  for a given problem. Without loss of generality, we may assume that the equilibrium point in question lies at the origin (since a simple translation will move it to the origin if it isn't already there.) In all cases we will require that:

- 1)  $V$  and its first partial derivatives must be continuous in some neighborhood of the origin, and
- 2)  $V(0, 0) = 0$ .

For a general system

$$\frac{dx_1}{dt} = f_1(x_1, x_2), \quad \frac{dx_2}{dt} = f_2(x_1, x_2) \quad (26)$$

we shall be concerned with  $dV/dt$  along trajectories. As in the example, we will compute this as:

$$\frac{dV}{dt} = \frac{\partial V}{\partial x_1} \frac{dx_1}{dt} + \frac{\partial V}{\partial x_2} \frac{dx_2}{dt} = \frac{\partial V}{\partial x_1} f_1(x_1, x_2) + \frac{\partial V}{\partial x_2} f_2(x_1, x_2) \quad (27)$$

We present the following three theorems without proof:

Theorem 1: If in some neighborhood of the origin,  $V$  is positive definite while  $dV/dt \leq 0$ , then the origin is Lyapunov stable.

Theorem 2: If in some neighborhood of the origin,  $V$  and  $-dV/dt$  are both positive definite, then the origin is asymptotically Lyapunov stable.

Theorem 3: If in some neighborhood of the origin,  $dV/dt$  is positive definite, and if  $V$  can take on positive values arbitrarily near the origin (but not necessarily everywhere in some neighborhood of the origin), then the origin is Lyapunov unstable.

Using these theorems, the validity of the linearized variational equations can be established under appropriate conditions on the eigenvalues. Suppose the system is written in the form:

$$\frac{dx_1}{dt} = ax_1 + bx_2 + F_1(x_1, x_2), \quad \frac{dx_2}{dt} = cx_1 + dx_2 + F_2(x_1, x_2) \quad (28)$$

where  $F_1(x_1, x_2)$  and  $F_2(x_1, x_2)$  are strictly nonlinear, i.e. they contain quadratic and higher order terms. Writing this in vector form, where  $x = [x_1 \ x_2]^T$  and  $F = [F_1 \ F_2]^T$ ,

$$\frac{dx}{dt} = Ax + F(x) \quad (29)$$

Transforming to eigencoordinates  $y$ , we set  $x = Ty$ , where  $T$  is a matrix which has the eigenvectors of  $A$  as its columns, and obtain:

$$\frac{dy}{dt} = T^{-1}ATy + T^{-1}F(Ty) = Dy + G(y) \quad (30)$$

where  $D$  is a diagonal matrix (the theorem also holds if  $D$  is in Jordan form), and where  $G = T^{-1}F$  is strictly nonlinear in  $y$ .

Theorem 4:  $x = 0$  is asymptotically Lyapunov stable if all the eigenvalues of  $A$  have negative real parts.

Take  $V = y_1 \bar{y}_1 + y_2 \bar{y}_2$ , where  $\bar{y}_i$  is the complex conjugate of  $y_i$ . Then  $V$  so defined is certainly positive definite. For asymptotic stability we need to show that  $-dV/dt$  is positive definite.

$$\frac{dV}{dt} = y_1 \frac{d\bar{y}_1}{dt} + \frac{dy_1}{dt} \bar{y}_1 + y_2 \frac{d\bar{y}_2}{dt} + \frac{dy_2}{dt} \bar{y}_2 \quad (31)$$

Now we have that

$$\frac{dy_i}{dt} = \lambda_i y_i + G_i \quad \text{and} \quad \frac{d\bar{y}_i}{dt} = \bar{\lambda}_i \bar{y}_i + \bar{G}_i \quad (32)$$

so that (31) becomes

$$\frac{dV}{dt} = (\lambda_1 + \bar{\lambda}_1) y_1 \bar{y}_1 + (\lambda_2 + \bar{\lambda}_2) y_2 \bar{y}_2 + \text{cubic and higher order nonlinear terms} \quad (33)$$

which gives

$$-\frac{dV}{dt} = -2 \operatorname{Re}(\lambda_1) y_1 \bar{y}_1 - 2 \operatorname{Re}(\lambda_2) y_2 \bar{y}_2 + \text{cubic and higher order nonlinear terms} \quad (34)$$

Thus in some neighborhood of the origin, the cubic and higher order nonlinear terms in (34) are dominated by the quadratic terms, which themselves are positive definite if  $\operatorname{Re}(\lambda_i) < 0$  for  $i = 1, 2$ . Thus  $-dV/dt$  is positive definite and the origin is asymptotically stable by Theorem 2.

In a similar way we can use Theorem 3 to prove

Theorem 5:  $x = 0$  is Lyapunov unstable if at least one eigenvalue of  $A$  has positive real part.

The idea of the proof is the same as for Theorem 4, except now take  $V = y_1 \bar{y}_1 - y_2 \bar{y}_2$  if, for example,  $\operatorname{Re}(\lambda_1) > 0$  and  $\operatorname{Re}(\lambda_2) < 0$ . (The case where  $\operatorname{Re}(\lambda_2) = 0$  is more complicated and we omit discussion of it.)

An excellent reference on Lyapunov's Direct Method is "Stability by Liapunov's Direct Method with Applications" by J.P.LaSalle and S.Lefschetz, Academic Press, 1961.

## 2 The Duffing Oscillator

The differential equation

$$\frac{d^2x}{dt^2} + x + \epsilon\alpha x^3 = 0, \quad \epsilon > 0 \quad (35)$$

is called the Duffing oscillator. It is a model of a structural system which includes nonlinear restoring forces (for example springs). It is sometimes used as an approximation for the pendulum:

$$\frac{d^2\theta}{dt^2} + \frac{g}{L} \sin \theta = 0 \quad (36)$$

Expanding  $\sin \theta = \theta - \frac{\theta^3}{6} + O(\theta^5)$ , and then setting  $\theta = \sqrt{\epsilon}x$ ,

$$\frac{d^2x}{dt^2} + \frac{g}{L} \left( x - \epsilon \frac{x^3}{6} \right) = 0(\epsilon^2) \quad (37)$$

Now we stretch time with  $z = \sqrt{\frac{g}{L}}t$ ,

$$\frac{d^2x}{dz^2} + x - \epsilon \frac{x^3}{6} = 0(\epsilon^2) \quad (38)$$

which is (35) with  $\alpha = -1/6$ .

In order to understand the dynamics of Duffing's equation (35), we begin by writing it as a first order system:

$$\frac{dx}{dt} = y, \quad \frac{dy}{dt} = -x - \epsilon\alpha x^3 \quad (39)$$

For a given initial condition  $(x(0), y(0))$ , eq.(39) specifies a *trajectory* in the  $x$ - $y$  phase plane, i.e. the motion of a point in time. The *integral curve* along which the point moves satisfies the d.e.

$$\frac{dy}{dx} = \frac{\frac{dy}{dt}}{\frac{dx}{dt}} = \frac{-x - \epsilon\alpha x^3}{y} \quad (40)$$

Eq.(40) may be easily integrated to give

$$\frac{y^2}{2} + \frac{x^2}{2} + \epsilon\alpha \frac{x^4}{4} = \text{constant} \quad (41)$$

Eq.(41) corresponds to the physical principle of conservation of energy. In the case that  $\alpha$  is positive, (41) represents a continuum of closed curves surrounding the origin, each of which represents a motion of eq.(35) which is periodic in time. In the case that  $\alpha$  is negative, all motions which start sufficiently close to the origin are periodic. However, in this case eq.(39) has two additional equilibrium points besides the origin, namely  $x = \pm 1/\sqrt{-\epsilon\alpha}, y = 0$ . The integral curves which go through these points separate motions which are periodic from motions which grow unbounded, and are called *separatrices* (singular: *separatrix*).

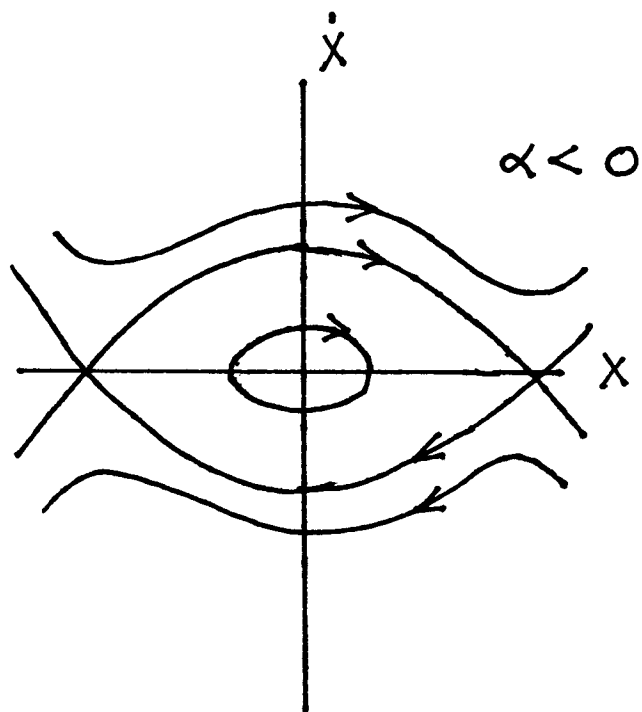
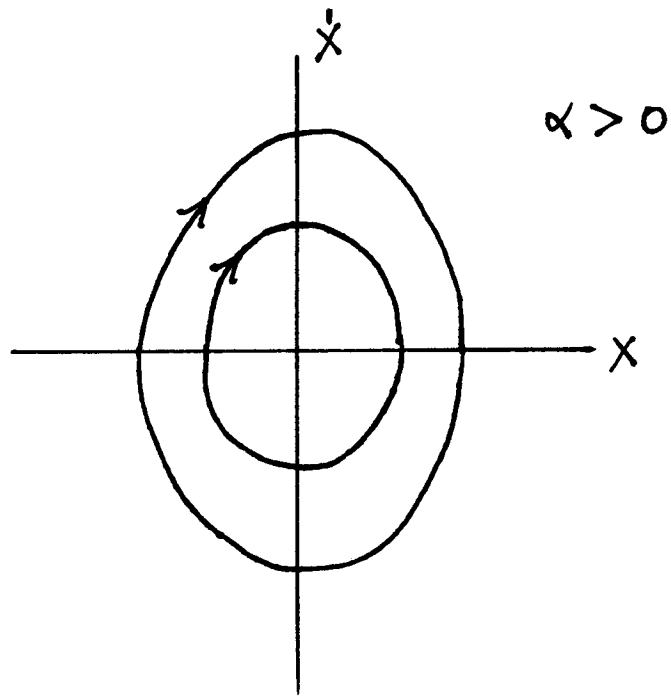

Phase plane for Duffing's equation

If we were to numerically integrate eq.(35), we would see that the period of the periodic motions depended on which closed curve in the phase plane we were on. This effect is typical of nonlinear vibrations and is referred to as the dependence of period on amplitude. In the next section we will use a perturbation method to investigate this.

### 2.1 Lindstedt's Method

Lindstedt's method is a simple singular perturbation scheme which can be used to derive the relationship between period and amplitude in Duffing's equation (35). The idea is to build the period-amplitude relationship into the approximate solution by stretching time:

$$\tau = \omega t, \quad \text{where} \quad \omega = 1 + k_1\epsilon + k_2\epsilon^2 + \dots \tag{42}$$

where the coefficients  $k_i$  are to be found. Substituting (42) into (35), we get

$$\omega^2 \frac{d^2x}{d\tau^2} + x + \epsilon\alpha x^3 = 0 \tag{43}$$

Next we expand  $x$  in a power series in  $\epsilon$ :

$$x(\tau) = x_0(\tau) + \epsilon x_1(\tau) + \epsilon^2 x_2(\tau) + \dots \tag{44}$$

In view of the power series expansions (42) and (44), the results obtained by Lindstedt's method are expected only to be valid for small values of  $\epsilon$ . Substituting (44) into (43) and collecting terms gives:

$$\frac{d^2x_0}{d\tau^2} + x_0 = 0 \tag{45}$$

$$\frac{d^2x_1}{d\tau^2} + x_1 = -2k_1 \frac{d^2x_0}{d\tau^2} - \alpha x_0^3 \tag{46}$$

$$\frac{d^2x_2}{d\tau^2} + x_2 = -2k_1 \frac{d^2x_1}{d\tau^2} - (2k_2 + k_1^2) \frac{d^2x_0}{d\tau^2} - 3\alpha x_0^2 x_1 \tag{47}$$

Eq.(45) has the solution

$$x_0(\tau) = A \cos \tau \tag{48}$$

Here  $A$  is the amplitude of the motion, and we have chosen the phase arbitrarily, a step which is possible because of the *autonomous* nature of eq.(35), i.e. the *explicit* absence of the independent variable  $t$  in (35). Substituting (45) into (46) gives

$$\frac{d^2x_1}{d\tau^2} + x_1 = 2Ak_1 \cos \tau - A^3\alpha \cos^3 \tau \tag{49}$$

Simplifying the trig term  $\cos^3 \tau$  gives

$$\frac{d^2x_1}{d\tau^2} + x_1 = \left(2Ak_1 - \frac{3A^3\alpha}{4}\right) \cos \tau - \frac{A^3\alpha}{4} \cos 3\tau \tag{50}$$

For a periodic solution, we require the coefficient of  $\cos \tau$  on the right hand side of eq.(50) to vanish. This key step is called removal of *resonance* or *secular* terms. We obtain

$$2Ak_1 - \frac{3A^3\alpha}{4} = 0, \quad \text{that is,} \quad k_1 = \frac{3}{8}\alpha A^2 \quad (51)$$

Substituting this result into the ansatz (42), we obtain the approximate frequency-amplitude relation:

$$\omega = 1 + k_1\epsilon + O(\epsilon^2) = 1 + \frac{3}{8}\alpha A^2\epsilon + O(\epsilon^2) \quad (52)$$

The period  $T = 2\pi/\omega$  may then be written as:

$$T = \frac{2\pi}{\omega} = \frac{2\pi}{1 + \frac{3}{8}\alpha A^2\epsilon + O(\epsilon^2)} = 2\pi \left( 1 - \frac{3}{8}\alpha A^2\epsilon + O(\epsilon^2) \right) \quad (53)$$

We may continue the process to obtain higher order approximations as follows. Substituting condition (51) into eq.(50), we may solve for  $x_1(\tau)$ :

$$x_1(\tau) = \frac{A^3\alpha}{32}(\cos 3\tau - \cos \tau) \quad (54)$$

Here we have chosen the complementary solution in order that the amplitude of vibration be given by  $A$ , that is, in order that  $x(0) = A$ , cf. eq.(44). Substituting (54) into the  $x_2$  equation, (47), we may again remove secular terms and thereby obtain an expression for  $k_2$ . The process may be continued indefinitely.

## 2.2 Elliptic Functions

Although most nonlinear differential equations are not solvable in terms of tabulated functions, it turns out that Duffing's eq.(35) may be solved exactly in terms of Jacobian elliptic functions. In this section we will collect together some facts about elliptic functions which will permit us to solve eq.(35). Our motivation is two-fold: firstly to check the approximate results obtained by Lindstedt's method, and secondly to provide a basis for perturbation methods which begin with the elliptic function solution of Duffing's equation. We use the notation of "Handbook of Elliptic Integrals for Engineers and Physicists" by P.Byrd and M.Friedman, Springer Verlag, 1954.

There are three elliptic functions: sn, cn and dn. The sn function is odd and may be thought of as the elliptic version of the trig function sine, while the cn function is even and may be thought of as the elliptic version of the trig function cosine. These are related by the identity

$$\text{sn}^2 + \text{cn}^2 = 1 \quad (55)$$

which is reminiscent of the comparable trig identity. In contrast to sine and cosine, the three elliptic functions sn,cn and dn each depend on two variables,

$$\text{sn} = \text{sn}(u, k), \quad \text{cn} = \text{cn}(u, k), \quad \text{dn} = \text{dn}(u, k) \quad (56)$$

where  $u$  is called the *argument* and  $k$  is called the *modulus*. (Note that in contrast to Byrd and Friedman, other standard treatments use  $m = k^2$  instead of  $k$ . In particular, this is true



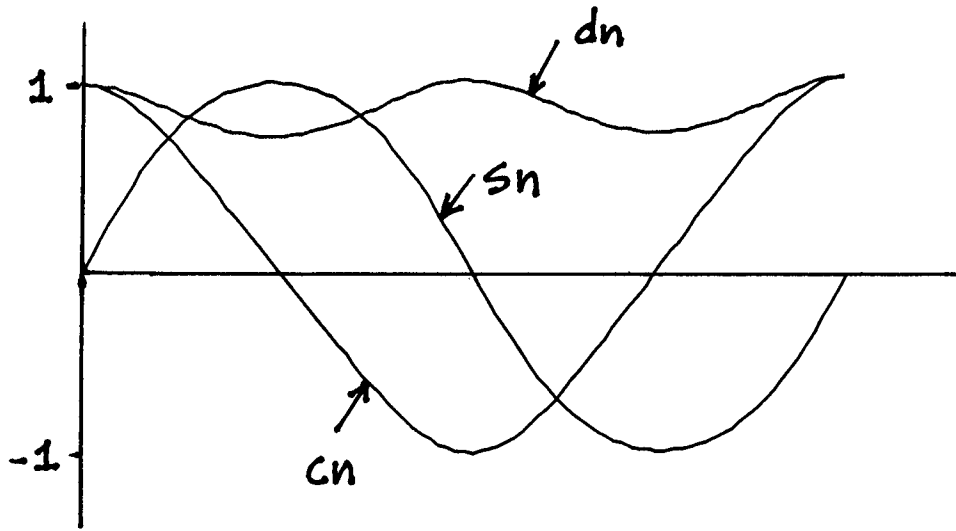

Elliptic functions

of “Handbook of Mathematical Functions” by M.Abramowitz and I.Stegun, Dover Publications, 1965.) The elliptic function sn reduces to sine when  $k = 0$ , and cn reduces to cosine when  $k = 0$ . There is no trig counterpart to dn, which reduces to unity when  $k = 0$ . The formulas for the derivatives of sn and cn are reminiscent of their trig counterparts:

$$\frac{\partial}{\partial u} \text{sn} = \text{cn} \text{ dn}, \quad \frac{\partial}{\partial u} \text{cn} = -\text{sn} \text{ dn} \tag{57}$$

The elliptic function dn satisfies the following equations:

$$\frac{\partial}{\partial u} \text{dn} = -k^2 \text{sn} \text{ cn}, \quad \text{and} \quad k^2 \text{sn}^2 + \text{dn}^2 = 1 \tag{58}$$

The period of sn and cn in their argument  $u$  is  $4K$ , where  $K(k)$  is the complete elliptic integral of the first kind. The period of dn is  $2K$ . As  $k$  goes from zero to unity,  $K(k)$  goes monotonically from  $\pi/2$  to infinity. In the limit as  $k$  approaches unity, the elliptic functions approach the following hyperbolic trig functions:

$$\text{sn}(u, 1) = \tanh u, \quad \text{cn}(u, 1) = \text{sech } u, \quad \text{dn}(u, 1) = \text{sech } u \tag{59}$$

In order to compare the exact solution which we shall derive to eq.(35) with the approximate solution obtained by Lindstedt’s method, we will need the following expansion for  $K(k)$  (from Byrd and Friedman, p.296, formula no.900.00):

$$K(k) = \frac{\pi}{2} \left[ 1 + \frac{1}{4}k^2 + \frac{9}{64}k^4 + \frac{25}{256}k^6 + O(k^8) \right] \tag{60}$$

In order to obtain an exact solution to eq.(35), we look for a solution in the form of a cn function:

$$x(t) = a_1 \text{cn}(u, k), \quad u = a_2 t + b \tag{61}$$

Since eq.(35) is a second order o.d.e., its general solution will possess two arbitrary constants. Since it is an autonomous o.d.e., one of the arbitrary constants will be the phase  $b$ . Of the other three constants,  $a_1, a_2$  and  $k$ , only one is independent. In order to obtain the relations between these three, we substitute (61) into (35) and use the foregoing elliptic function identities. To begin with, let us take the derivative of (61) with respect to  $t$ :

$$\frac{dx}{dt} = a_1 a_2 \frac{\partial}{\partial u} \text{cn} = -a_1 a_2 \text{sn} \text{ dn} \tag{62}$$

where for brevity we write  $\text{cn} = \text{cn}(u, k)$ ,  $\text{sn} = \text{sn}(u, k)$  and  $\text{dn} = \text{dn}(u, k)$ . Differentiating (62),

$$\frac{d^2x}{dt^2} = -a_1 a_2^2 \left( \text{sn} \frac{\partial}{\partial u} \text{dn} + \text{dn} \frac{\partial}{\partial u} \text{sn} \right) = -a_1 a_2^2 (\text{cn} \text{ dn}^2 - k^2 \text{sn}^2 \text{cn}) \tag{63}$$

Using the identities (55) and (58), this becomes

$$\frac{d^2x}{dt^2} = -a_1 a_2^2 \text{cn} (1 - 2k^2 + 2k^2 \text{cn}^2) \tag{64}$$

Substituting (64) into Duffing's equation (35), and equating to zero the coefficients of  $\text{cn}$  and  $\text{cn}^3$  gives two equations relating  $a_1, a_2$  and  $k$ :

$$a_1(2a_2^2k^2 - a_2^2 + 1) = 0 \tag{65}$$

$$-a_1(2a_2^2k^2 - a_1^2\alpha\epsilon) = 0 \tag{66}$$

These may be solved for  $a_2$  and  $k$  in terms of  $a_1$ :

$$a_2^2 = 1 + a_1^2\alpha\epsilon, \quad k^2 = \frac{a_1^2\alpha\epsilon}{2(1 + a_1^2\alpha\epsilon)} \tag{67}$$

Eq.(61) together with (67) is the exact solution to Duffing's equation (35). Note that if  $\alpha$  is positive, then  $k$  will be real, but if  $\alpha$  is negative,  $k$  may be imaginary. In the latter case, we may obtain a real form of the solution by using the following identity (from Byrd and Friedman, p.38, 160.01):

$$\text{cn}(u, ik) = \frac{\text{cn}\left(u\sqrt{1+k^2}, \tilde{k}\right)}{\text{dn}\left(u\sqrt{1+k^2}, \tilde{k}\right)}, \quad \text{where } \tilde{k} = \frac{k}{\sqrt{1+k^2}} \tag{68}$$

We shall use the exact solution to check the approximate period-amplitude relation (53) obtained by Lindstedt's method. The amplitude of the exact solution (61) is  $a_1$  which we will identify with the amplitude  $A$  of eqs.(48),(53). The period  $T$  of the exact solution (61) is  $4K(k)/a_2$  which may be written, using eq.(60),

$$T = \frac{4K(k)}{a_2} = 4\frac{\pi}{2a_2} \left[ 1 + \frac{1}{4}k^2 + \frac{9}{64}k^4 + \frac{25}{256}k^6 + O(k^8) \right] \tag{69}$$

Substituting eqs.(67) and expanding for small  $\epsilon$ , we obtain:

$$T = 2\pi \left( 1 - \frac{3}{8}\alpha A^2\epsilon + \frac{57}{256}\alpha^2 A^4\epsilon^2 + \dots \right) \tag{70}$$

which agrees with eq.(53).

## 2.3 Problems

### Problem 2.1

This problem concerns a nonlinear oscillator with quadratic nonlinearity:

$$\frac{d^2x}{dt^2} + x + \epsilon x^2 = 0 \tag{71}$$

Compute the period for  $\epsilon = 0.1$  and the initial condition  $x(0) = 1, \frac{dx}{dt}(0) = 0$  in three different ways, and compare your answers:

- Using numerical integration (Runge Kutta).
- Using Lindstedt's method. Include terms of  $O(\epsilon^2)$ .
- Using elliptic functions. Hint:  $x = a_0 + a_1 \text{sn}^2(u, k), u = a_2t + b$

**Problem 2.2**

For the oscillator:

$$\frac{d^2x}{dt^2} + x + \epsilon ax^2 + \epsilon^2 bx^3 = 0 \quad (72)$$

What relation between parameters  $a$  and  $b$  makes the frequency independent of amplitude if terms of  $O(\epsilon^3)$  are neglected?

### 3 The van der Pol Oscillator

The differential equation

$$\frac{d^2x}{dt^2} + x - \epsilon(1 - x^2)\frac{dx}{dt} = 0, \quad \epsilon > 0 \quad (73)$$

is called the van der Pol oscillator. It is a model of a nonconservative system in which energy is added to and subtracted from the system in an autonomous fashion, resulting in a periodic motion called a *limit cycle*. Here we can see that the sign of the damping term,  $-\epsilon(1 - x^2)\frac{dx}{dt}$  changes, depending upon whether  $|x|$  is larger or smaller than unity. Van der Pol's equation has been used as a model for stick-slip oscillations, aero-elastic flutter, and numerous biological oscillators, to name but a few of its applications.

Numerical integration of eq.(73) shows that every initial condition (except  $x = \frac{dx}{dt} = 0$ ) approaches a unique periodic motion. The nature of this limit cycle is dependent on the value of  $\epsilon$ . For small values of  $\epsilon$  the motion is nearly sinusoidal, whereas for large values of  $\epsilon$  it is a *relaxation* oscillation, meaning that it tends to resemble a series of step functions, jumping between positive and negative values twice per cycle. If we write (73) as a first order system,

$$\frac{dx}{dt} = y, \quad \frac{dy}{dt} = -x + \epsilon(1 - x^2)y \quad (74)$$

we find that there is no exact closed form solution. Numerical integration shows that the limit cycle is a closed curve enclosing the origin in the  $x$ - $y$  phase plane. From the fact that eqs.(74) are invariant under the transformation  $x \mapsto -x$ ,  $y \mapsto -y$ , we may conclude that the curve representing the limit cycle is point symmetric about the origin.

#### 3.1 The Method of Averaging

We could obtain an analytic approximation for the limit cycle in (73) by using Lindstedt's method. However, in order to obtain information regarding the *approach* to the limit cycle, we will need a more powerful perturbation method called the method of averaging. We begin with a system of the more general form:

$$\frac{d^2x}{dt^2} + x = \epsilon F\left(x, \frac{dx}{dt}, t\right) \quad (75)$$

We seek a solution to (75) in the form:

$$x = a(t) \cos(t + \psi(t)), \quad \frac{dx}{dt} = -a(t) \sin(t + \psi(t)) \quad (76)$$

Our motivation for this ansatz is that when  $\epsilon$  is zero, (75) has its solution of the form (76) with  $a$  and  $\psi$  constants. For small values of  $\epsilon$  we expect the same form of the solution to be approximately valid, but now  $a$  and  $\psi$  are expected to be slowly varying functions of  $t$ . Differentiating the first of (76) and requiring the second of (76) to hold, we obtain:

$$\frac{da}{dt} \cos(t + \psi) - a \frac{d\psi}{dt} \sin(t + \psi) = 0 \quad (77)$$

Limit cycles in van der Pol's equation from his paper in Phil.Mag., 1926.

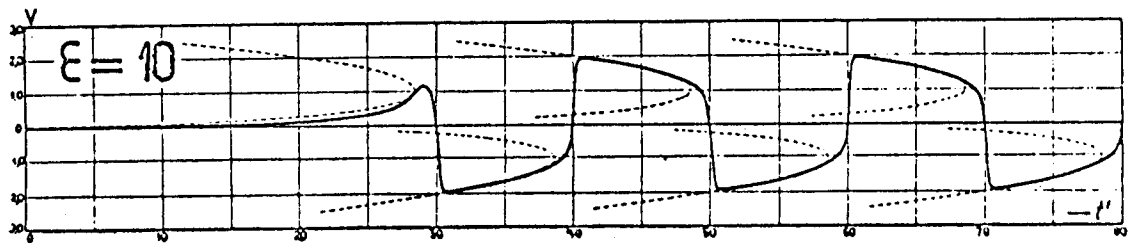
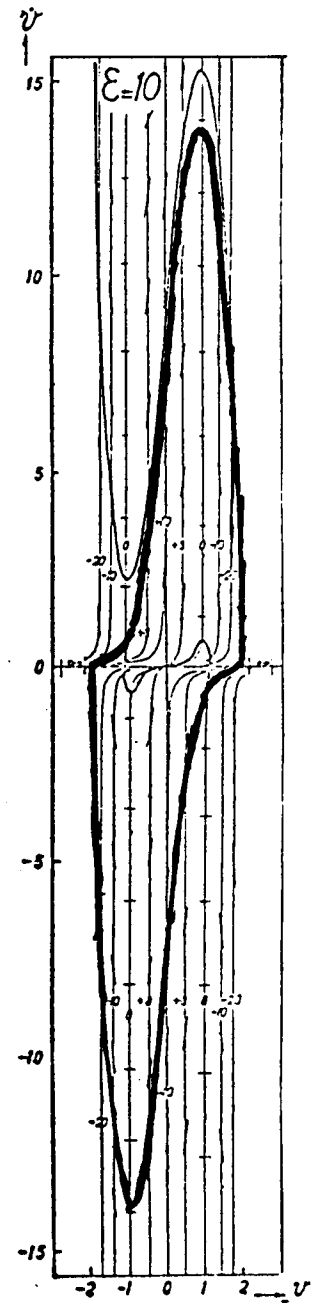
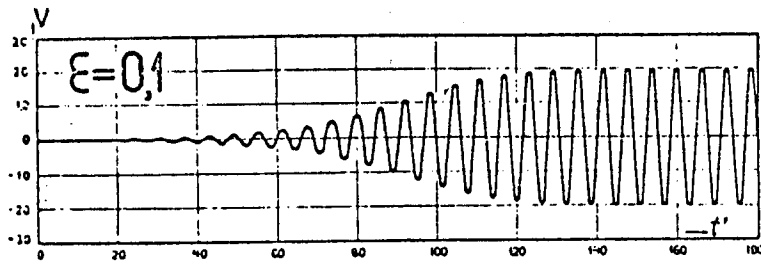
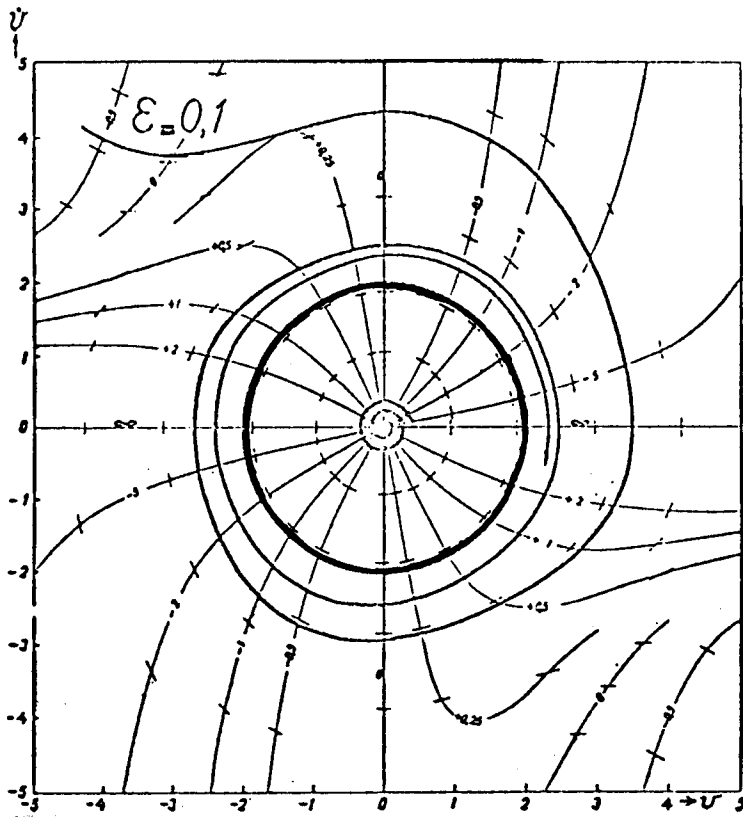

Differentiating the second of (76) and substituting the result into (75) gives

$$-\frac{da}{dt} \sin(t + \psi) - a \frac{d\psi}{dt} \cos(t + \psi) = \epsilon F(a \cos(t + \psi), -a \sin(t + \psi), t) \quad (78)$$

Solving eqs.(77) and (78) for  $\frac{da}{dt}$  and  $\frac{d\psi}{dt}$ , we obtain:

$$\frac{da}{dt} = -\epsilon \sin(t + \psi) F(a \cos(t + \psi), -a \sin(t + \psi), t) \quad (79)$$

$$\frac{d\psi}{dt} = -\frac{\epsilon}{a} \cos(t + \psi) F(a \cos(t + \psi), -a \sin(t + \psi), t) \quad (80)$$

So far our treatment has been exact and is nothing but the procedure of variation of parameters which is used in linear differential equations to obtain particular solutions to nonhomogenous o.d.e.'s. Now we introduce an approximation in the form of a *near-identity transformation* which is written as a power series in  $\epsilon$ :

$$a = \bar{a} + \epsilon w_1(\bar{a}, \bar{\psi}, t) + O(\epsilon^2) \quad (81)$$

$$\psi = \bar{\psi} + \epsilon w_2(\bar{a}, \bar{\psi}, t) + O(\epsilon^2) \quad (82)$$

where  $w_1$  and  $w_2$  are called *generating functions*, to be chosen so that the transformed equations on  $\bar{a}$  and  $\bar{\psi}$  are as simple as possible. Substituting (81),(82) into (79),(80) and neglecting terms of  $O(\epsilon^2)$ , we obtain:

$$\frac{d\bar{a}}{dt} = \epsilon \left( -\frac{\partial w_1}{\partial t} - \sin(t + \bar{\psi}) F(\bar{a} \cos(t + \bar{\psi}), -\bar{a} \sin(t + \bar{\psi}), t) \right) + O(\epsilon^2) \quad (83)$$

$$\frac{d\bar{\psi}}{dt} = \epsilon \left( -\frac{\partial w_2}{\partial t} - \frac{\cos(t + \bar{\psi})}{\bar{a}} F(\bar{a} \cos(t + \bar{\psi}), -\bar{a} \sin(t + \bar{\psi}), t) \right) + O(\epsilon^2) \quad (84)$$

Now the question is how to choose the generating functions  $w_1$  and  $w_2$ ? It is tempting to try to wipe out the  $O(\epsilon)$  parts of the right hand sides of eqs.(83) and (84) by choosing

$$w_1 = \int_0^t -\sin(t + \bar{\psi}) F(\bar{a} \cos(t + \bar{\psi}), -\bar{a} \sin(t + \bar{\psi}), t) dt \quad (85)$$

and a similar expression for  $w_2$ . There is a problem with this choice, however. It is that the integral in (85) will in general have a nonzero average, which means that as  $t$  increases,  $w_1$  will also increase, on the average linearly in  $t$ . Now if  $w_1$  grows like  $t$ , then the near-identity transformation (81) will be messed up: specifically, the  $\epsilon w_1$  term, which is assumed to be small for small  $\epsilon$ , will eventually grow large as  $t$  approaches infinity. The expansion (81) will not be uniformly valid on the infinite time interval. In order to avoid this technical difficulty, we choose  $w_1$  and  $w_2$  to wipe out all the  $O(\epsilon)$  terms on the right hand sides of eqs.(83) and (84) *except for their average value!* This results in the following d.e.'s on  $\bar{a}$  and  $\bar{\psi}$ :

$$\frac{d\bar{a}}{dt} = -\epsilon \frac{1}{T} \int_0^T \sin(t + \bar{\psi}) F(\bar{a} \cos(t + \bar{\psi}), -\bar{a} \sin(t + \bar{\psi}), t) dt + O(\epsilon^2) \quad (86)$$

$$\frac{d\bar{\psi}}{dt} = -\epsilon \frac{1}{T} \int_0^T \frac{\cos(t + \bar{\psi})}{\bar{a}} F(\bar{a} \cos(t + \bar{\psi}), -\bar{a} \sin(t + \bar{\psi}), t) dt + O(\epsilon^2) \quad (87)$$

Note this is partial integration in the sense that  $\bar{a}$  and  $\bar{\psi}$  are held fixed during the integration process. Here  $T$  is the period over which the average is to be taken. If  $F(x, \frac{dx}{dt}, t)$  is periodic in  $t$  with a certain period  $P$ , then we take  $T = P$ . This is the case of an nonautonomous system with periodic forcing. On the other hand, if  $t$  does not explicitly appear in  $F$ , then we take the averaging period  $T = 2\pi$ , the period of the unforced ( $\epsilon = 0$ ) oscillator in (75). In this case the d.e. is autonomous, as in van der Pol's equation (73). For an autonomous system, the integration in eqs.(86),(87) may be simplified by replacing the variable  $t$  with  $\phi = t + \bar{\psi}$ :

$$\frac{d\bar{a}}{dt} = -\epsilon \frac{1}{2\pi} \int_0^{2\pi} \sin \phi F(\bar{a} \cos \phi, -\bar{a} \sin \phi) d\phi + O(\epsilon^2) \tag{88}$$

$$\frac{d\bar{\psi}}{dt} = -\epsilon \frac{1}{2\pi} \int_0^{2\pi} \frac{\cos \phi}{\bar{a}} F(\bar{a} \cos \phi, -\bar{a} \sin \phi) d\phi + O(\epsilon^2) \tag{89}$$

For small  $\epsilon$ , eqs.(86),(87) or eqs.(88),(89) are called *slow flow* equations, since they specify the evolution of  $\bar{a}$  and  $\bar{\psi}$  on a slow time scale (slow time= $\epsilon t$ ). In the nonautonomous case, the slow flow (86),(87) is autonomous, since  $t$  has been averaged out. In the autonomous case, the slow flow (88),(89) depends only on  $\bar{a}$ , since  $\phi$  has been averaged out. In this case the slow flow simplifies to two uncoupled first order o.d.e.'s. Thus in both nonautonomous systems and in autonomous systems, the slow flow resulting from the method of averaging is easier to treat than the original system.

Often when the method of averaging is presented in textbooks, the near-identity transformation is omitted, and the discussion is simplified as follows. One leaps directly from eqs.(79),(80) to eqs.(86),(87) by reasoning that since  $\epsilon$  is small,  $\frac{da}{dt}$  and  $\frac{d\psi}{dt}$  are also small, and hence  $a$  and  $\psi$  are slowly varying, and thus over one cycle of duration  $T$  the quantities  $a$  and  $\psi$  on the right hand sides of eqs.(79),(80) are nearly constant, and thus these right hand sides may be approximately replaced by their averages as in eqs.(86),(87). Since this argument is quite compelling, you may ask why we bother with the intricacies associated with the near-identity transformation.

The advantage of the near-identity transformation is two-fold. Firstly, after solving the slow flow eqs.(86),(87) or eqs.(88),(89) for  $\bar{a}$  and  $\bar{\psi}$ , we may achieve greater accuracy by transforming back to  $a$  and  $\psi$  via the near-identity transformation. We speak of the solution of the slow flow eqs. without the use of the near-identity transformation as *simple averaging* or *first order averaging*, whereas we refer to the procedure of combining the solution of the slow flow eqs. with the near-identity transformation as *one and a half order averaging*.

The second advantage of using the near-identity transformation is that the averaging procedure may be extended to any order of approximation by continuing the process. For example we may replace eqs.(81),(82) by

$$a = \bar{a} + \epsilon w_1(\bar{a}, \bar{\psi}, t) + \epsilon^2 v_1(\bar{a}, \bar{\psi}, t) + O(\epsilon^3) \tag{90}$$

$$\psi = \bar{\psi} + \epsilon w_2(\bar{a}, \bar{\psi}, t) + \epsilon^2 v_2(\bar{a}, \bar{\psi}, t) + O(\epsilon^3) \tag{91}$$

where  $w_1$  and  $w_2$  take on the values which we have already found, and where  $v_1$  and  $v_2$  are to be determined by an entirely analogous process. The method may be similarly extended to any order of approximation.



Now we shall apply the method of averaging to van der Pol's equation (73). Comparing (75) with (73), we obtain

$$F\left(x, \frac{dx}{dt}, t\right) = (1 - x^2) \frac{dx}{dt} \tag{92}$$

Eqs.(88),(89) become, neglecting terms of  $O(\epsilon^2)$ :

$$\frac{d\bar{a}}{dt} = \epsilon \frac{1}{2\pi} \int_0^{2\pi} (1 - \bar{a}^2 \cos^2 \phi)(\bar{a} \sin^2 \phi) d\phi = \epsilon \frac{\bar{a}}{8}(4 - \bar{a}^2) \tag{93}$$

$$\frac{d\bar{\psi}}{dt} = \epsilon \frac{1}{2\pi} \int_0^{2\pi} \cos \phi (1 - \bar{a}^2 \cos^2 \phi)(\sin \phi) d\phi = 0 \tag{94}$$

Before solving eq.(93), we note that it has nonnegative equilibria at  $\bar{a} = 2, 0$ . Thus for small  $\epsilon$  the limit cycle is approximately a circle of radius 2 in the  $x$ - $\frac{dx}{dt}$  phase plane. Moreover, the flow along the  $\bar{a}$ -line in (93) shows that  $\bar{a} = 2$  is attractive, which means that the limit cycle is asymptotically stable.

Eq.(93) can be solved by separating variables and using partial fractions, giving:

$$\bar{a}(t) = \frac{2 \exp \frac{\epsilon t}{2}}{\sqrt{\exp \epsilon t - 1 + \frac{4}{\bar{a}(0)^2}}} \tag{95}$$

As  $t \rightarrow \infty, \bar{a}(t) \rightarrow 2$ , which confirms the asymptotic stability of the limit cycle. For large  $t$ , (95) becomes

$$\bar{a}(t) \sim 2 + e^{-\epsilon t} \left(-1 + \frac{4}{\bar{a}(0)^2}\right) + \dots \tag{96}$$

showing that the approach to the limit cycle goes like  $e^{-\epsilon t}$ .

It is interesting to examine what happens in eq.(95) as time  $t$  runs backwards. For  $\bar{a}(0) < 2$ , we find that  $\bar{a}(t) \rightarrow 0$  as  $t \rightarrow -\infty$ , that is, motions starting inside the limit cycle in the phase plane approach the equilibrium point at the origin asymptotically as time runs backwards. However, for  $\bar{a}(0) > 2, \bar{a}(t)$  blows up when the denominator of (95) vanishes, that is, for  $t = \frac{\ln(1-4/\bar{a}(0)^2)}{\epsilon} < 0$ . Thus motions starting outside the limit cycle in the phase plane escape to infinity in *finite time* as time runs backwards! This escape to infinity in finite time is reminiscent of the behavior of the simple example

$$\frac{dx}{dt} = x^2 \tag{97}$$

which has the general solution

$$x(t) = \frac{1}{\frac{1}{x(0)} - t} \tag{98}$$

and which sends a motion starting at  $x(0)$  at  $t = 0$  out to infinity as  $t \rightarrow \frac{1}{x(0)}$ , that is, in finite time.

### 3.2 Hopf Bifurcations

Before proceeding to further examine the properties of van der Pol's equation, we pause to consider how a limit cycle may get born. In particular we consider the following equation, which is a generalization of van der Pol's equation:

$$\frac{d^2z}{dt^2} + z = c \frac{dz}{dt} + \alpha_1 z^2 + \alpha_2 z \frac{dz}{dt} + \alpha_3 \left(\frac{dz}{dt}\right)^2 + \beta_1 z^3 + \beta_2 z^2 \frac{dz}{dt} + \beta_3 z \left(\frac{dz}{dt}\right)^2 + \beta_4 \left(\frac{dz}{dt}\right)^3 \quad (99)$$

where  $c$  is the coefficient of linear damping, where the  $\alpha_i$  are coefficients of quadratic nonlinear terms, and where the  $\beta_i$  are coefficients of cubic nonlinear terms. For some values of these parameters, eq.(99) may exhibit a limit cycle, whereas for other values it may not. We are interested in understanding how such a periodic solution can be born as the parameters are varied.

We shall investigate this question by using Lindstedt's method. We begin by introducing a small parameter  $\epsilon$  into (99) by the scaling  $z = \epsilon x$ , which gives:

$$\frac{d^2x}{dt^2} + x = c \frac{dx}{dt} + \epsilon \left[ \alpha_1 x^2 + \alpha_2 x \frac{dx}{dt} + \alpha_3 \left(\frac{dx}{dt}\right)^2 \right] + \epsilon^2 \left[ \beta_1 x^3 + \beta_2 x^2 \frac{dx}{dt} + \beta_3 x \left(\frac{dx}{dt}\right)^2 + \beta_4 \left(\frac{dx}{dt}\right)^3 \right] \quad (100)$$

There remains the question of how to scale the coefficient of linear damping  $c$ . Let us expand  $c$  in a power series in  $\epsilon$ :

$$c = c_0 + c_1 \epsilon + c_2 \epsilon^2 + \dots \quad (101)$$

In order to perturb off of the simple harmonic oscillator, we must take  $c_0 = 0$ . Next consider  $c_1$ . As we shall see, although the quadratic terms are of  $O(\epsilon)$ , their first contribution to secular terms in Lindstedt's method occurs at  $O(\epsilon^2)$ . Thus if  $c_1$  were not zero, the perturbation method would fail to obtain a limit cycle regardless of the values of the  $\alpha_i$  and  $\beta_i$  coefficients. Physically speaking, the damping would be too strong relative to the nonlinearities for a limit cycle to exist. Thus we scale the coefficient  $c$  to be  $O(\epsilon^2)$ , and we set  $c = \epsilon^2 \mu$ :

$$\frac{d^2x}{dt^2} + x = \epsilon \left[ \alpha_1 x^2 + \alpha_2 x \frac{dx}{dt} + \alpha_3 \left(\frac{dx}{dt}\right)^2 \right] + \epsilon^2 \left[ \mu \frac{dx}{dt} + \beta_1 x^3 + \beta_2 x^2 \frac{dx}{dt} + \beta_3 x \left(\frac{dx}{dt}\right)^2 + \beta_4 \left(\frac{dx}{dt}\right)^3 \right] \quad (102)$$

In order to apply Lindstedt's method to eq.(102), we first set  $\tau = \omega t$ , and then we expand:

$$\omega = 1 + k_1 \epsilon + k_2 \epsilon^2 + \dots, \quad x(\tau) = x_0(\tau) + \epsilon x_1(\tau) + \epsilon^2 x_2(\tau) + \dots \quad (103)$$

Substituting (103) into (102) and collecting terms gives:

$$\frac{d^2x_0}{d\tau^2} + x_0 = 0 \quad (104)$$

$$\frac{d^2x_1}{d\tau^2} + x_1 = -2k_1 \frac{d^2x_0}{d\tau^2} + \alpha_1 x_0^2 + \alpha_2 x_0 \frac{dx_0}{d\tau} + \alpha_3 \left(\frac{dx_0}{d\tau}\right)^2 \quad (105)$$

$$\frac{d^2x_2}{d\tau^2} + x_2 = 12 \text{ terms which are not listed for brevity} \quad (106)$$

We take the solution to eq.(104) as

$$x_0(\tau) = A \cos \tau \tag{107}$$

Substituting (107) into (105) and simplifying the trig terms requires us to take  $k_1 = 0$  for no secular terms, and we obtain the following expression for  $x_1(\tau)$ :

$$x_1(\tau) = \frac{A^2}{6} (3(\alpha_1 + \alpha_3) + (\alpha_3 - \alpha_1) \cos 2\tau + \alpha_2 \sin 2\tau) \tag{108}$$

Substituting these results into the  $x_2$  equation (106) and requiring the coefficients of both the  $\sin \tau$  and  $\cos \tau$  to vanish (for no secular terms), we obtain:

$$A = 2\sqrt{\frac{-\mu}{\alpha_2(\alpha_1 + \alpha_3) + \beta_2 + 3\beta_4}} \tag{109}$$

as well as an expression for  $k_2$  which we omit here for brevity.

According to this approximate analysis, a limit cycle will exist if the expression (109) for the amplitude  $A$  is real. This requires that the linear damping coefficient  $\mu$  have the opposite sign to the quantity  $S$  defined by

$$S = \alpha_2(\alpha_1 + \alpha_3) + \beta_2 + 3\beta_4 \tag{110}$$

If we imagine a situation in which  $S$  is fixed and  $\mu$  is allowed to vary (quasistatically), then as  $\mu$  goes through the value zero, a limit cycle is either created or destroyed. This situation is called a *Hopf bifurcation*. There are two cases,  $S > 0$  and  $S < 0$ . In either case, the stability of the equilibrium point at the origin of the phase plane is influenced only by the sign of  $\mu$ , and not by the value of the  $\alpha_i$ 's or  $\beta_i$ 's. This may be seen by rewriting eq.(102) in the form

$$\frac{d^2x}{dt^2} + x - \epsilon^2 \mu \frac{dx}{dt} = \text{nonlinear terms} \tag{111}$$

from which we see that the origin is stable for  $\mu < 0$  and unstable for  $\mu > 0$ . Moreover the stability of the limit cycle is opposite to the stability of the origin since motions which leave the neighborhood of the origin must accumulate on the limit cycle because of the two-dimensional nature of the phase plane. Thus in the case  $S < 0$ , the limit cycle exists only when  $\mu > 0$ , in which case the origin is unstable and the limit cycle is stable. This case is called a supercritical Hopf. The other case, in which  $S > 0$  and which involves the limit cycle being unstable, is called a subcritical Hopf. In both cases the amplitude of the newly born limit cycle grows like  $\sqrt{|\mu|}$ , a function which has infinite slope at  $\mu = 0$ , so that the size of the limit cycle grows dramatically for parameters close to the bifurcation value of  $\mu = 0$ .

### 3.3 Homoclinic Bifurcations

In this section we will examine another way in which a limit cycle can be born. We will illustrate the phenomenon by investigating the system

$$\frac{d^2z}{dt^2} + z = -A \frac{dz}{dt} + z^3 - \left(\frac{dz}{dt}\right)^3 \tag{112}$$

SUPERCritical CASE,  $S < 0$

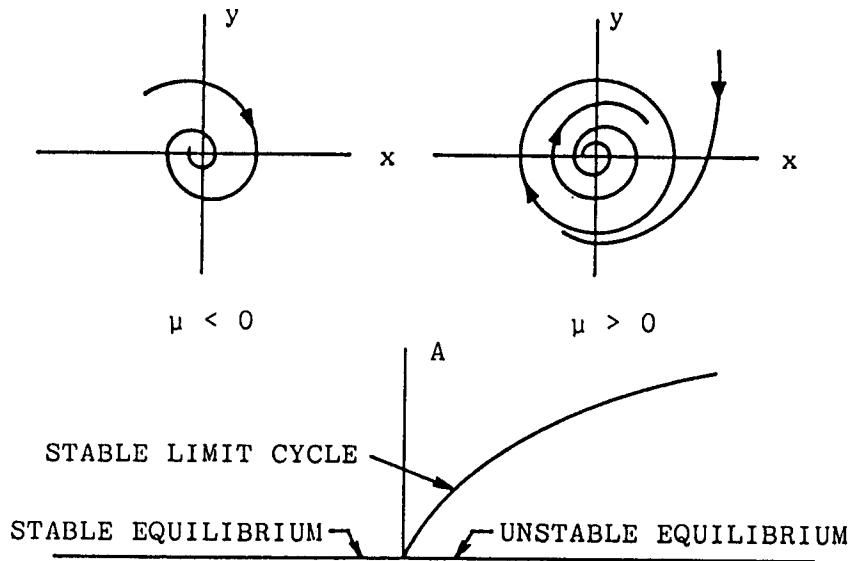

SUBCRITICAL CASE,  $S > 0$

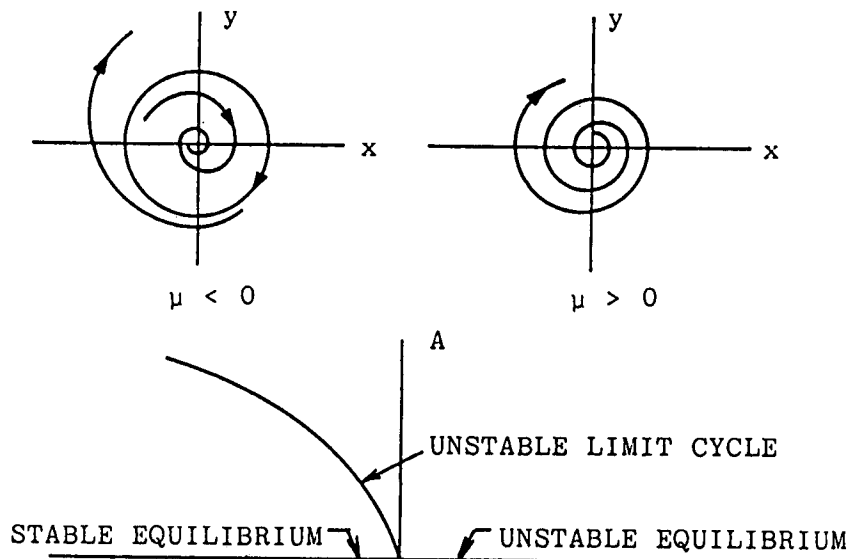

Supercritical and subcritical Hopf Bifurcations.  
 $A$  = amplitude of limit cycle.

where  $A$  is a parameter. We begin by writing eq.(112) as a first order system:

$$\frac{dz}{dt} = y, \quad \frac{dy}{dt} = -z - Ay + z^3 - y^3 \tag{113}$$

Eqs.(113) have three equilibria: two saddles at  $(z = \pm 1, y = 0)$  and a spiral at  $(z = 0, y = 0)$ . The spiral at the origin is stable for  $A > 0$  and unstable for  $A < 0$ . Thus we may expect a Hopf bifurcation to occur as  $A$  passes through zero. In order to determine whether the Hopf is supercritical or subcritical (that is, whether the resulting limit cycle is stable or unstable), we identify eq.(112) with eq.(99), and obtain  $c = -A$ ,  $\beta_1 = 1$ ,  $\beta_4 = -1$ , and  $\alpha_1 = \alpha_2 = \alpha_3 = \beta_2 = \beta_3 = 0$ . From eq.(109) we find that the amplitude in  $z$  of the limit cycle is approximately given by:

$$\text{Amplitude} = 2\sqrt{\frac{-c}{\alpha_2(\alpha_1 + \alpha_3) + \beta_2 + 3\beta_4}} = 2\sqrt{\frac{A}{-3}} \tag{114}$$

Thus the limit cycle occurs when  $A < 0$  and is stable (since the equilibrium at the origin is unstable for  $A < 0$ ). These conclusions are confirmed by numerical integration.

Numerical integration shows that as the parameter  $A$  is decreased, a dramatic change in the phase portrait is observed to occur between  $A = -0.33$  and  $A = -0.34$ . At  $A = -0.33$  the limit cycle (which has grown since its birth at  $A = 0$ ) continues to exist, while at  $A = -0.34$  there is no limit cycle. Somewhere between these two values of  $A$  a bifurcation occurred in which the limit cycle morphed into a pair of saddle connections at a critical value of  $A = A_{cr}$ . For values of  $A < A_{cr}$  neither the limit cycle nor the saddle connections exist. This scenario is called a *homoclinic bifurcation*.

In order to compute an approximate value for  $A_{cr}$ , we will use a perturbation method. The idea is to scale  $z$  so that for  $\epsilon = 0$  the system exhibits a pair of saddle connections (or separatrix loop). We write eq.(112) in the form:

$$\frac{d^2z}{dt^2} + z - z^3 = -A\frac{dz}{dt} - B\left(\frac{dz}{dt}\right)^3 \tag{115}$$

where we have introduced a new parameter  $B$ , to be set equal to 1 when we are finished with the perturbation method. Next we scale  $A = \epsilon\alpha$  and  $B = \epsilon\beta$ , giving

$$\frac{d^2z}{dt^2} + z - z^3 = \epsilon\left(-\alpha\frac{dz}{dt} - \beta\left(\frac{dz}{dt}\right)^3\right) \tag{116}$$

Now when  $\epsilon = 0$  we have a conservative system in which

$$\frac{1}{2}\left(\frac{dz}{dt}\right)^2 + \frac{z^2}{2} - \frac{z^4}{4} = h = \text{constant} \tag{117}$$

The unperturbed system (117) has a pair of saddle connections for  $h = 1/4$ . (Here we obtain  $h = 1/4$  by substituting  $z = \pm 1$ ,  $dz/dt = 0$  into eq.(117), since the saddle connection has to

Phase portraits (schematic) of

$$\ddot{z} + z + A\dot{z} - z^3 + \dot{z}^3 = 0$$

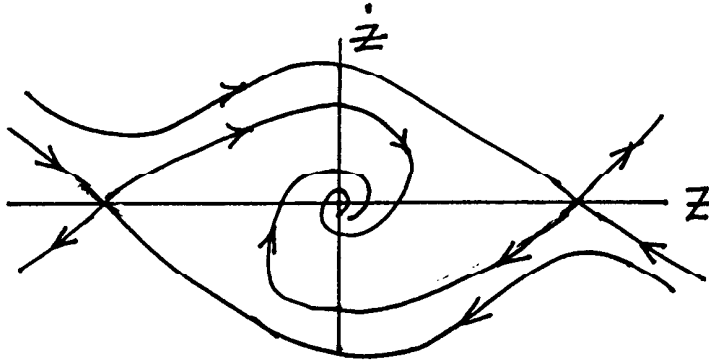

$A_{cr} < 0 < A$   
NO L.C.

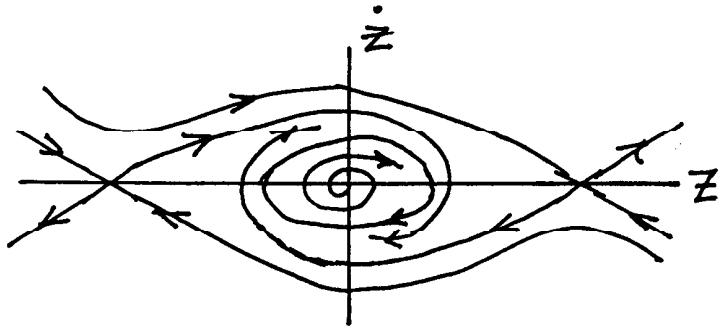

$A_{cr} < A < 0$   
STABLE L.C.

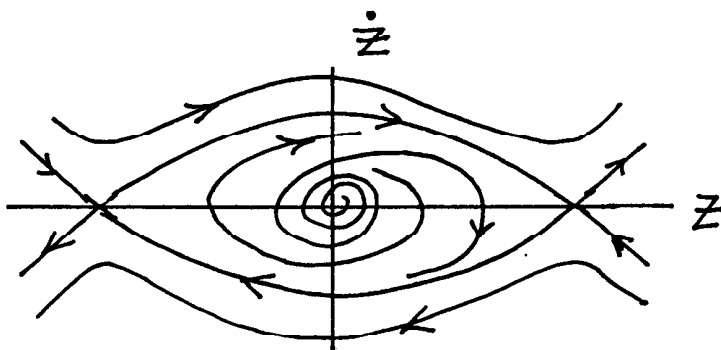

$A = A_{cr} \approx -0.34$   
SADDLE CONNECTIONS

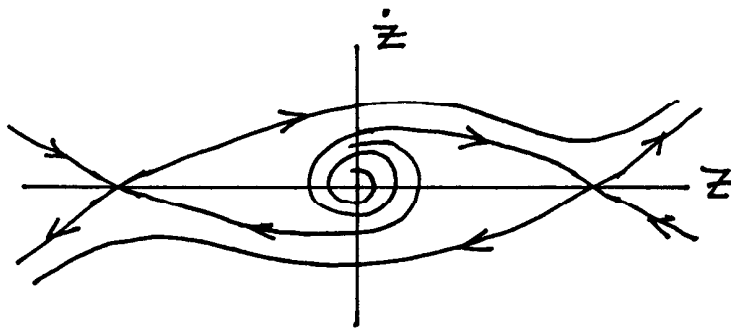

$A < A_{cr} < 0$   
NO L.C.

terminate at the saddles.)

In general the effect of making  $\epsilon > 0$  will be to break the separatrix loop. However, for a certain relationship between  $\alpha$  and  $\beta$ , the saddle connections will continue to exist, corresponding to the homoclinic bifurcation. Thus our strategy is to require that the perturbation leave the separatrix loop preserved.

At this point we generalize the discussion to a wider class of systems, returning to the example later. We consider a conservative (Hamiltonian) system of the form:

$$\frac{dz}{dt} = \frac{\partial H}{\partial y}, \quad \frac{dy}{dt} = -\frac{\partial H}{\partial z} \tag{118}$$

Note that eq.(118) possesses the first integral  $H(z, y) = \text{constant}$ , since  $dH/dt = H_z \dot{z} + H_y \dot{y} = 0$ . In the case of our example,  $H(z, y) = y^2/2 + z^2/2 - z^4/4$ , cf. eq.(117).

Now we add the perturbation to the conservative system (118):

$$\frac{dz}{dt} = \frac{\partial H}{\partial y} + \epsilon g_1, \quad \frac{dy}{dt} = -\frac{\partial H}{\partial z} + \epsilon g_2 \tag{119}$$

where  $g_1$  and  $g_2$  are given functions of  $z$  and  $y$ . For example, in the system (116), we find that  $g_1 = 0$  and  $g_2 = -\alpha y - \beta y^3$ .

For the system (119), the condition for the separatrix loop to be preserved turns out to be:

$$\int \int_{\text{int } \Gamma} \frac{\partial g_1}{\partial z} + \frac{\partial g_2}{\partial y} dz dy = 0 \tag{120}$$

where  $\Gamma$  represents the unperturbed separatrix loop, and  $\text{int } \Gamma$  is the region of the  $z$ - $y$  plane inside the curve  $\Gamma$ . Eq.(120) may be derived by using Green's theorem as follows:

$$\epsilon \int \int_{\text{int } \Gamma} \frac{\partial g_1}{\partial z} + \frac{\partial g_2}{\partial y} dz dy = \epsilon \int \int_{\text{int } \Gamma} \frac{\partial}{\partial z} \left( \frac{\partial H}{\partial y} + \epsilon g_1 \right) + \frac{\partial}{\partial y} \left( -\frac{\partial H}{\partial z} + \epsilon g_2 \right) dz dy \tag{121}$$

$$= \oint_{\Gamma} \left( \frac{\partial H}{\partial y} + \epsilon g_1 \right) dy - \left( -\frac{\partial H}{\partial z} + \epsilon g_2 \right) dz \tag{122}$$

$$= \oint_{\Gamma} \frac{dz}{dt} dy - \frac{dy}{dt} dz = \oint_{\Gamma} \left( \frac{dz}{dt} \frac{dy}{dt} - \frac{dy}{dt} \frac{dz}{dt} \right) dt = 0 \tag{123}$$

Eq.(120) is approximate because we have substituted the unperturbed separatrix loop  $\Gamma$  for the actual (perturbed) curve of motion. However, it is valid for small  $\epsilon$ .

A more convenient form for eq.(120) may be obtained as follows:

$$\int \int_{\text{int } \Gamma} \frac{\partial g_1}{\partial z} + \frac{\partial g_2}{\partial y} dz dy = \oint_{\Gamma} g_1 dy - g_2 dz \tag{124}$$

$$= \oint_{\Gamma} \left( g_1 \frac{dy}{dt} - g_2 \frac{dz}{dt} \right) dt \tag{125}$$

$$= \oint_{\Gamma} \left( -g_1 \frac{\partial H}{\partial z} - g_2 \frac{\partial H}{\partial y} \right) dt + O(\epsilon) = 0 \tag{126}$$

Returning to the example (116), we substitute  $H = y^2/2 + z^2/2 - z^4/4$ ,  $g_1 = 0$  and  $g_2 = -\alpha y - \beta y^3$  into eq.(126), giving:

$$\oint_{\Gamma} -(-\alpha y - \beta y^3) y dt = \int_{-\infty}^{\infty} \left[ \alpha \left( \frac{dz}{dt} \right)^2 + \beta \left( \frac{dz}{dt} \right)^4 \right] dt = 0 \tag{127}$$

To evaluate the integral (127), we need  $z(t)$  on the saddle connection. From (117) with  $h = 1/4$ , we obtain:

$$\int \frac{dz}{\sqrt{\frac{1}{2} - z^2 + \frac{1}{2}z^4}} = \int \frac{\sqrt{2} dz}{1 - z^2} = \int dt \tag{128}$$

$$\operatorname{arctanh} z = \frac{1}{\sqrt{2}} t \tag{129}$$

Thus  $z = \tanh \frac{t}{\sqrt{2}}$  and  $dz/dt = \frac{1}{\sqrt{2}} \operatorname{sech}^2 \frac{t}{\sqrt{2}}$ . We substitute this expression for  $dz/dt$  into (127) and evaluate the integral using computer algebra (macsyma). The result is:

$$35\alpha + 12\beta = 0 \tag{130}$$

Multiplying (130) by  $\epsilon$  and using  $A = \epsilon\alpha$  and  $B = \epsilon\beta = 1$ , we obtain an expression for the homoclinic bifurcation value of  $A = A_{cr}$ :

$$A_{cr} = -\frac{12}{35} = -0.343 \tag{131}$$

which approximately agrees with the results of numerical integration.

See “Stability, Instability and Chaos” by P.Glendinning, Cambridge, 1994 for more on this and related bifurcations.

### 3.4 Relaxation Oscillations

We have seen that for small values of  $\epsilon$ , the limit cycle in van der Pol’s equation (73) is nearly a circle of radius 2 in the phase plane, and its frequency is approximately equal to unity. The character of the limit cycle gradually changes as  $\epsilon$  is increased, until for very large values of  $\epsilon$  it becomes a relaxation oscillation. In this section we obtain an approximation for the limit cycle for large  $\epsilon$  by using a perturbation technique called matched asymptotic expansions.

We begin by defining a new small parameter,  $\epsilon_0 = \frac{1}{\epsilon} \ll 1$ . Substituting this in eq.(73) gives:

$$\epsilon_0 \frac{d^2 x}{dt^2} + \epsilon_0 x - (1 - x^2) \frac{dx}{dt} = 0 \tag{132}$$

Next we scale time by setting  $t = \epsilon_0^\nu t_1$ , where  $\nu$  is to be determined:

$$\epsilon_0^{1-2\nu} \frac{d^2 x}{dt_1^2} + \epsilon_0 x - \epsilon_0^{-\nu} (1 - x^2) \frac{dx}{dt_1} = 0 \tag{133}$$



The idea of the method is to select  $\nu$  so that we get a *distinguished limit*, that is, so that two of the three terms in eq.(133) are of the same order of  $\epsilon_0$ , and are larger than the other term. The first and third terms will balance if  $1 - 2\nu = -\nu$ , that is, if  $\nu = 1$ . Another distinguished limit is  $\nu = -1$ , for which value the second and third terms will balance. We consider each of these limits separately.

First we set  $\nu = -1$  in eq.(133), which gives

$$x - (1 - x^2) \frac{dx}{dt_1} + \epsilon_0^2 \frac{d^2x}{dt_1^2} = 0, \quad t_1 = \epsilon_0 t \tag{134}$$

Note that  $t_1$  is slow time. Neglecting terms of  $O(\epsilon_0^2)$ , we get a first order d.e. which can be solved by separation of variables:

$$\frac{(1 - x^2)}{x} dx = dt_1 \quad \Rightarrow \quad \ln |x| - \frac{x^2}{2} = t_1 + \text{constant} \tag{135}$$

The motion proceeds according to eq.(135) until it reaches  $x = \pm 1$  where the speed  $dx/dt_1$  is infinite. At this point the motion undergoes a jump, the dynamics of which are given by the other distinguished limit, as follows. We set  $\nu = 1$  in eq.(133), and to avoid confusion of notation, we use  $(y, t_2)$  here in place of  $(x, t_1)$

$$\frac{d^2y}{dt_2^2} - (1 - y^2) \frac{dy}{dt_2} + \epsilon_0^2 y = 0, \quad t_2 = \frac{t}{\epsilon_0} \tag{136}$$

Note that  $t_2$  is fast time. Neglecting terms of  $O(\epsilon_0^2)$ , we get a second order d.e. which has the following first integral:

$$\frac{d}{dt_2} \left( \frac{dy}{dt_2} - y + \frac{y^3}{3} \right) = 0 \quad \Rightarrow \quad \frac{dy}{dt_2} - y + \frac{y^3}{3} = \text{constant} \tag{137}$$

The second equation of (137) gives a flow along the  $y$ -line which represents a jump in the relaxation oscillation. We wish to choose the constant of integration so that  $y = 1$  is an equilibrium point of this flow, in which case the motion will proceed from  $y = 1$  to some as yet unknown second equilibrium point, which will determine the size of the jump. (The value  $y = 1$  is obtained from the other distinguished limit, eq.(135), as described above.) For an equilibrium at  $y = 1$ , we find

$$\frac{dy}{dt_2} = 0 = y - \frac{y^3}{3} + \text{constant} = 1 - \frac{1}{3} + \text{constant} \quad \Rightarrow \quad \text{constant} = -\frac{2}{3} \tag{138}$$

Using this value of the integration constant in eq.(137), we obtain

$$\frac{dy}{dt_2} = y - \frac{y^3}{3} - \frac{2}{3} = -\frac{1}{3}(y - 1)^2(y + 2) \tag{139}$$

From (139) we see that the second equilibrium point lies at  $y = -2$ . Thus the jump goes from  $y = 1$  to  $y = -2$ . In a similar fashion we would find that a jump starting at  $y = -1$  ends up at  $y = 2$ .

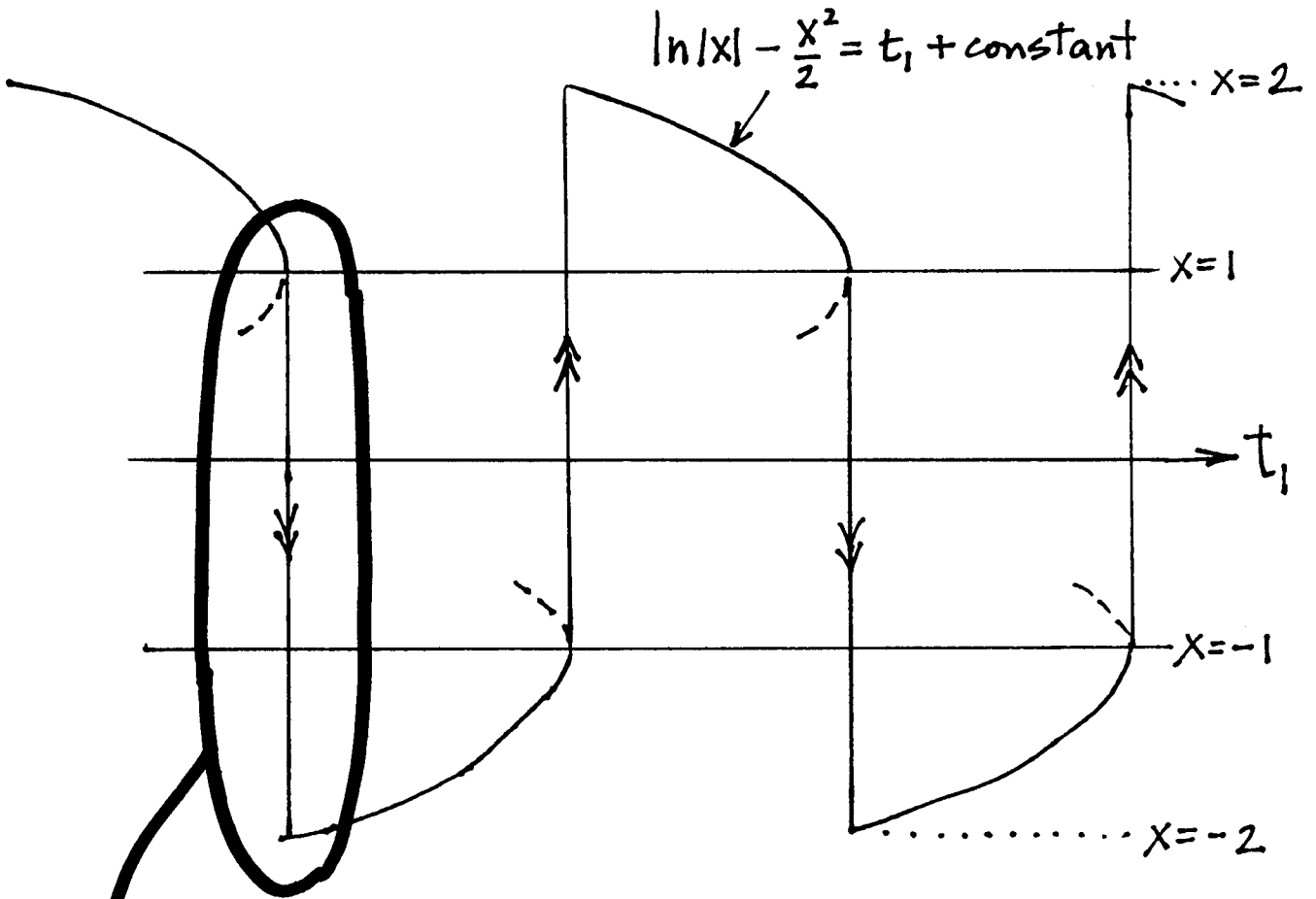

Flow along the  $y$ -line:

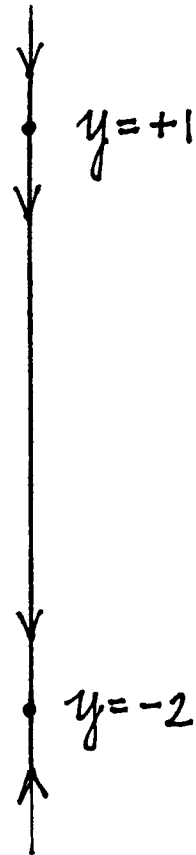

It remains to compute the period of the relaxation oscillation. Since  $t_2$  is fast time and  $t_1$  is slow time, the time spent in making the jump is negligible compared to the time spent moving according to the second equation in (135). That is, half the period is spent in going from  $x = 2$  to  $x = 1$  via eq.(135), then a nearly instantaneous jump occurs from  $x = 1$  to  $x = -2$ , then the other half of the period is spent in going from  $x = -2$  to  $x = -1$ , again via eq.(135), and finally another nearly instantaneous jump occurs from  $x = -1$  to  $x = 2$ .

$$\text{Half-period on } t_1 \text{ time scale} = \left[ \ln |x| - \frac{x^2}{2} \right]_{x=2}^{x=1} = \frac{3}{2} - \ln 2 \tag{140}$$

If we let  $T$  represent the period of the limit cycle on the original time scale  $t$ , we find

$$T = (3 - 2 \ln 2) \epsilon \approx 1.614 \epsilon \tag{141}$$

Note that the period  $T$  grows without bound as  $\epsilon \rightarrow \infty$ .

### 3.5 The van der Pol oscillator at Infinity

Poincare invented a scheme for examining the behavior of a flow on the phase plane “at infinity”, that is, at large distances from the origin. The idea is to map the plane onto a sphere. The sphere has unit radius and sits on the plane at  $x = y = 0$ . The mapping is achieved by projecting from the center of the sphere. Note that this is in contrast to the Riemann sphere of complex variables, where the projection is made from the north pole. In the case of Poincare’s sphere, each point on the plane is mapped to two points on the sphere, and infinity on the plane corresponds to the equator on the sphere. Because of the 1-to-2 nature of the map, we will be interested in examining only the lower hemisphere.

Let the origin  $O$  of the  $x$ - $y$ - $z$  coordinate system lie at the sphere’s center with the  $z$  axis pointing down towards the plane, and with the  $x$  and  $y$  directions parallel to those of the plane. A point  $P$  located at  $(x, y)$  on the plane will have coordinates  $(x, y, 1)$  when viewed in three dimensions.

$$P = (x, y, 1) \tag{142}$$

The vector  $OP$  will pierce the lower hemisphere at a point, call it  $P_1$ . Since the vector  $OP_1$  lies along the vector  $OP$ , the former must be a multiple of the latter, giving

$$P_1 = k (x, y, 1) \tag{143}$$

Here  $k$  must be chosen so that the length of  $OP_1$  is unity, giving  $k = \frac{1}{\sqrt{x^2+y^2+1}}$ . The resulting expression for  $P_1$  is nasty:

$$P_1 = \left( \frac{x}{\sqrt{x^2 + y^2 + 1}}, \frac{y}{\sqrt{x^2 + y^2 + 1}}, \frac{1}{\sqrt{x^2 + y^2 + 1}} \right) \tag{144}$$

Since we are interested mainly in the nature of the motion at infinity, that is, in the neighborhood of the equator of the sphere, Poincare came up with a scheme for simplifying the algebra involved in the transformation. The idea is to project onto the plane  $x = 1$  instead of projecting

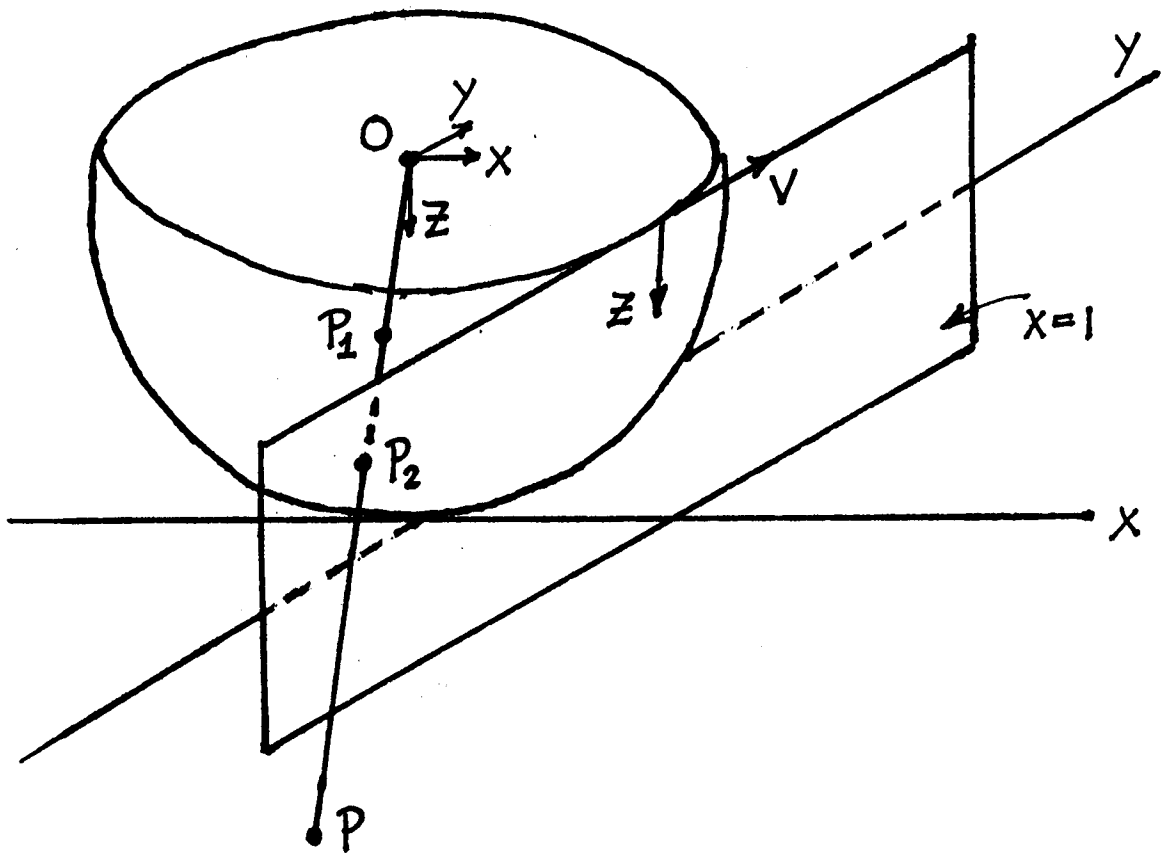

onto the sphere. The plane  $x = 1$  is tangent to the sphere at the point  $(1,0,0)$ , and thus gives a topologically consistent picture of the flow in the neighborhood of the equator, everywhere except at points located near  $(0,1,0)$ . The projection fails at “the ends of the  $y$ -axis”. To see what is going on there, we use the same idea, but project onto the plane  $y = 1$ .

Let  $P_2$  be the point at which the vector  $OP$  pierces the plane  $x = 1$ . As before we may write

$$P_2 = k (x, y, 1) \tag{145}$$

where this time  $k$  must be chosen so that the  $x$  coordinate of  $P_2$  is unity, that is,  $k = 1/x$ . This gives:

$$P_2 = (1, \frac{y}{x}, \frac{1}{x}) \tag{146}$$

Now we imagine a coordinate system located on the plane  $x = 1$  with its origin at the point of tangency with the sphere,  $(1,0,0)$ , and with coordinates  $v$  and  $\tilde{z}$ . Here  $v$  is directed parallel to the  $y$  axis and  $\tilde{z}$  is parallel to the  $z$  axis. Since no confusion results from identifying  $\tilde{z}$  with  $z$ , we drop the tilde. Thus we are led to make the following transformation of coordinates

$$v = \frac{y}{x}, \quad z = \frac{1}{x} \tag{147}$$

Substituting (147) into van der Pol’s equation,

$$\frac{dx}{dt} = y, \quad \frac{dy}{dt} = -x + \epsilon(1 - x^2)y \tag{148}$$

we obtain

$$\frac{dv}{dt} = \frac{-\epsilon v + z^2(\epsilon v - v^2 - 1)}{z^2}, \quad \frac{dz}{dt} = -vz \tag{149}$$

In order to avoid the singularity at  $z = 0$ , we reparametrize time by replacing  $t$  with  $\tau$ , where

$$d\tau = \frac{dt}{z^2} \tag{150}$$

Using (150), eqs.(149) become:

$$\frac{dv}{d\tau} = -\epsilon v + z^2(\epsilon v - v^2 - 1), \quad \frac{dz}{d\tau} = -vz^3 \tag{151}$$

Note that  $z = 0$  is an exact solution to eqs.(151). An algebraic equation between  $v$  and  $z$  which satisfies both differential equations is called an *invariant manifold*. Flow on the invariant manifold  $z = 0$  (the line at infinity), is given by:

$$\frac{dv}{d\tau} = -\epsilon v \tag{152}$$

Thus for  $\epsilon > 0$ , trajectories move in towards  $v = z = 0$  along  $z = 0$ . In order to determine what happens in the neighborhood of  $v = z = 0$  off the line  $z = 0$ , we look for another invariant manifold in the form:

$$v = a_1 z + a_2 z^2 + a_3 z^3 + a_4 z^4 + \dots \tag{153}$$

Differentiating (153) with respect to  $\tau$ , we obtain

$$\frac{dv}{d\tau} = (a_1 + 2a_2z + 3a_3z^2 + 4a_4z^3) \frac{dz}{d\tau} + \dots \tag{154}$$

Substituting (151) into (154) gives

$$-\epsilon v + z^2(\epsilon v - v^2 - 1) = (a_1 + 2a_2z + 3a_3z^2 + 4a_4z^3) (-vz^3) + \dots \tag{155}$$

Substituting (153) into (155) and collecting terms gives:

$$-\epsilon a_1 z - (1 + a_2\epsilon)z^2 + (a_1 - a_3)\epsilon z^3 + a_2\epsilon z^4 + \dots = 0 \tag{156}$$

Equating to zero the coefficient of  $z^n$  for  $n = 1, 2, 3, 4, \dots$ , we obtain:

$$a_1 = 0, \quad a_2 = -\frac{1}{\epsilon}, \quad a_3 = 0, \quad a_4 = -\frac{1}{\epsilon} \tag{157}$$

Substituting (157) into (153), we obtain the following expression for the invariant manifold:

$$v = -\frac{z^2}{\epsilon} - \frac{z^4}{\epsilon} + \dots \tag{158}$$

In order to determine the flow on the invariant manifold (158), we substitute it into the second of eqs.(151):

$$\frac{dz}{d\tau} = \frac{z^5}{\epsilon} + \frac{z^7}{\epsilon} + \dots \tag{159}$$

Thus on the invariant manifold (158) the flow is away from the point  $v = z = 0$ , while on the invariant manifold  $z = 0$  we saw in eq.(152) that the flow was in towards  $v = z = 0$ . This permits us to conclude that the equilibrium  $v = z = 0$  on the line at infinity is a saddle.

As mentioned above, the foregoing analysis is not valid at the ends of the  $y$  axis. To investigate what happens there, we would repeat the above procedure for the transformation:

$$u = \frac{x}{y}, \quad z = \frac{1}{y} \tag{160}$$

in which  $x$  and  $y$  have been interchanged and  $v$  has been replaced by  $u$  relative to the transformation (147). We omit this analysis here, but state that it reveals that the equilibrium point  $u = z = 0$  on the line at infinity is a source for  $\epsilon > 0$ . See ‘‘Perturbation Methods, Bifurcation Theory and Computer Algebra’’ by R.Rand and D.Armbruster, Springer, 1987, pp.71-84, for a complete treatment of this case.

In conclusion, we see that most trajectories coming from infinity approach the limit cycle in the van der Pol oscillator from a direction along the  $x$  axis, i.e. along the invariant manifold (158). Note that we have not assumed anything about the size of  $\epsilon$  in this section (in contrast to assumptions made in previous sections of this Chapter).

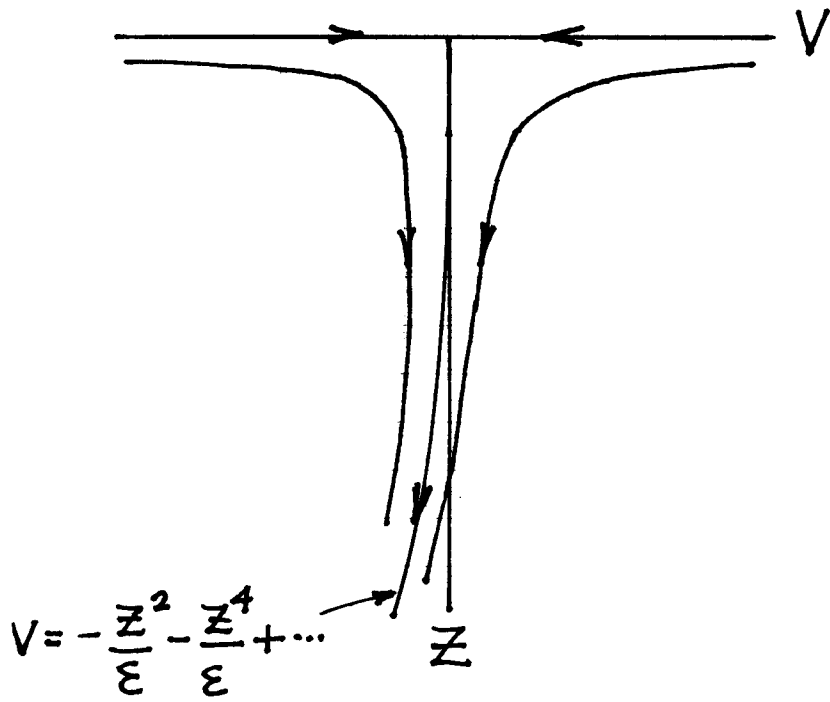

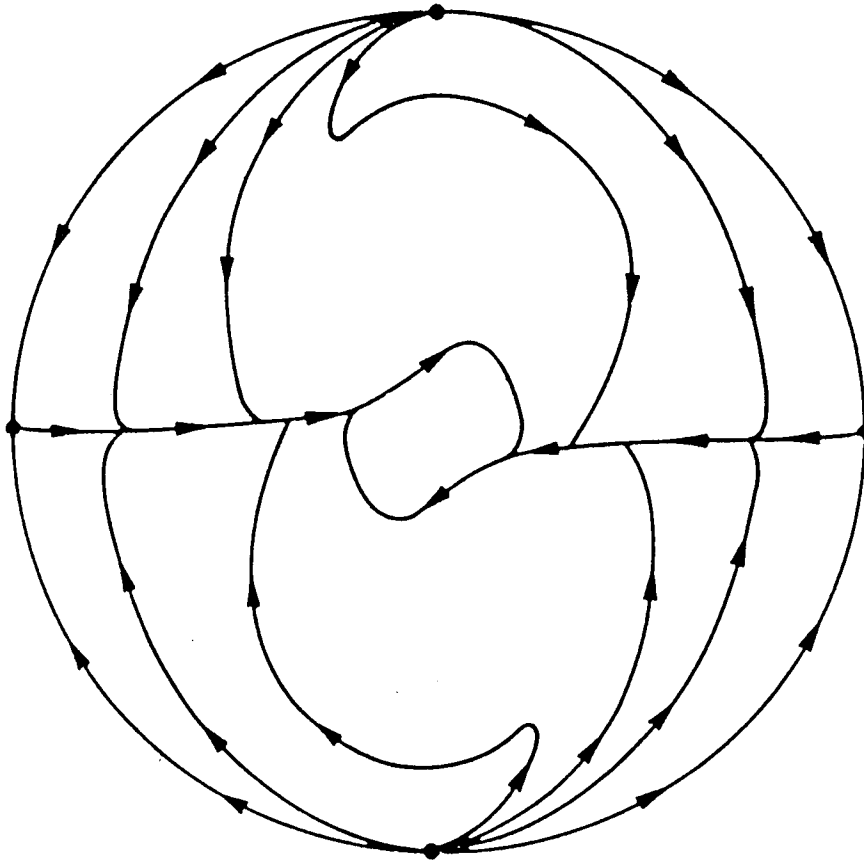

The global phase portrait for the Van der Pol equation. Here  $\epsilon = 1$ .



### 3.6 Example

Consider the following generalization of van der Pol's equation:

$$\frac{d^2x}{dt^2} + x - \epsilon \left( 1 - ax^2 - b \left( \frac{dx}{dt} \right)^2 \right) \frac{dx}{dt} = 0 \quad (161)$$

As parameters  $a$  and  $b$  are varied, this system exhibits a variety of phase portraits and behaviors at infinity. As shown in the accompanying Figure, there are 6 different cases, numbered I through VI. In cases II and VI some initial conditions escape to infinity, while others approach the stable limit cycle. As we cross the boundary from region III to region II, a limit cycle is born out of a closed loop consisting of 4 saddle-saddle connections between points at infinity. See "Dynamics of a System Exhibiting the Global Bifurcation of a Limit Cycle at Infinity" by W.L.Keith and R.H.Rand, *Int. J. Non-Linear Mechanics*, 20:325-338 (1985), from which the Figure is taken.

### 3.7 Problems

#### Problem 3.1

A Degenerate Limit Cycle. This problem concerns the equation

$$\frac{d^2x}{dt^2} + x + \epsilon \frac{dx}{dt} \left( 1 - \left( \frac{dx}{dt} \right)^2 + \beta \left( \frac{dx}{dt} \right)^4 \right) = 0$$

- Use Lindstedt's method including terms of  $O(\epsilon)$  to find  $\beta$  such that this equation exhibits a degenerate (semistable, double root) limit cycle.
- Using this value of  $\beta$  and the initial conditions  $x(0) = A$ ,  $\frac{dx}{dt}(0) = 0$ , continue Lindstedt's method to include terms of  $O(\epsilon^2)$ .
- Using the results of parts a and b, continue Lindstedt's method to include terms of  $O(\epsilon^3)$ . Something interesting happens at this order. What is this interesting thing, and what can you do about it?

Hint:  $\beta = \frac{9}{40}$ .

#### Problem 3.2

How Many Limit Cycles? This problem concerns the equation

$$\frac{d^2x}{dt^2} + x + 0.035 \frac{dx}{dt} + x^3 - 0.6 x^2 \frac{dx}{dt} + 0.1 \left( \frac{dx}{dt} \right)^3 = 0$$

$$\frac{d^2x}{dt^2} + x - \epsilon \left( 1 - ax^2 - b \left( \frac{dx}{dt} \right)^2 \right) \frac{dx}{dt} = 0$$

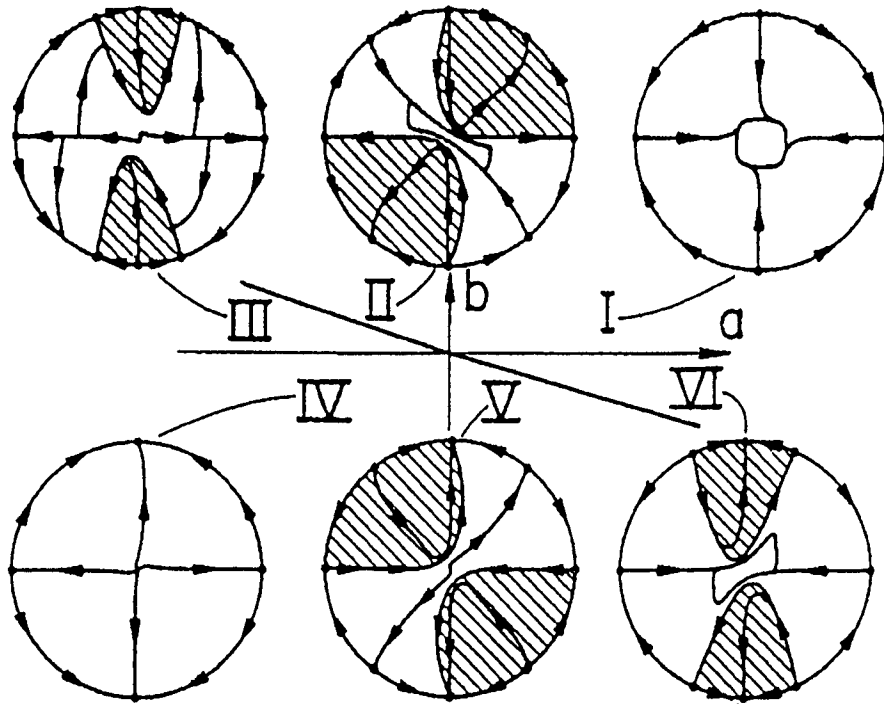

The global phase portraits corresponding to the six regions in parameter space, obtained from numerical integration and stability analysis of the fixed points at infinity. Points lying in the shaded regions come from and go to equilibria at infinity. Here  $\epsilon = 0.1$ .

We are interested in the number and location of any limit cycles which occur in this system. Investigate this question as follows:

- a. Use Lindstedt's method including terms of  $O(\epsilon)$  with the following scaling:

$$\frac{d^2x}{dt^2} + x + \epsilon \left( 0.35 \frac{dx}{dt} + 10x^3 - 6x^2 \frac{dx}{dt} + \left( \frac{dx}{dt} \right)^3 \right) = 0, \quad \text{where } \epsilon = 0.1$$

- b. Continue Lindstedt's method to include terms of  $O(\epsilon^2)$ .
- c. Use first order averaging.
- d. Use second order averaging.
- e. Numerically integrate the differential equation.

Compare the number of limit cycles predicted by each of these approximate methods. If they do not agree, explain why not.

### Problem 3.3

Relaxation Oscillations. This problem concerns the equation

$$\frac{d^2x}{dt^2} + x - \epsilon (1 + x - x^2) \frac{dx}{dt} = 0, \quad \epsilon \gg 1$$

- a. Follow the procedure given in the section on relaxation oscillations to find the period and amplitude of the limit cycle in this equation.
- b. Confirm your result by comparing with numerical integration for  $\epsilon = 10$ .

### Problem 3.4

Homoclinic Bifurcation. Find the critical value  $A_{cr}$  for a homoclinic bifurcation in the system:

$$\frac{d^2z}{dt^2} + z = -A \frac{dz}{dt} + z^3 - z^2 \frac{dz}{dt}$$

Check your analytical result by comparison with numerical integration.

## 4 The Forced Duffing Oscillator

The differential equation

$$\frac{d^2x}{dt^2} + x + \epsilon c \frac{dx}{dt} + \epsilon \alpha x^3 = \epsilon F \cos \omega t \quad (162)$$

is called the forced Duffing equation. It is used to model the forcing of a damped elastic structure when the displacements are sufficiently large to make nonlinear elastic effects significant. In contrast to the unforced Duffing equation (35), eq.(162) is nonautonomous, that is, time  $t$  explicitly appears in the equation in the  $\cos \omega t$  term. The phase plane is no longer a suitable arena in which to investigate this equation since the vector field at a given point changes in time, allowing a trajectory to return to that point and intersect itself. The system may be made autonomous, however, by increasing its dimension by one:

$$\frac{dx}{dt} = y \quad (163)$$

$$\frac{dy}{dt} = -x - \epsilon cy - \epsilon \alpha x^3 + \epsilon F \cos z \quad (164)$$

$$\frac{dz}{dt} = \omega \quad (165)$$

This system of three first order o.d.e.'s is defined on a phase space with topology  $R^2 \times S$ , where the circle  $S$  comes from the fact that the vector field of (163)-(165) is  $2\pi$ -periodic in  $z$ .

A convenient scheme for viewing this three-dimensional flow in two dimensions is by way of a *Poincare map*  $M$ . This map is generated by the flow's intersection with a *surface of section*  $\Sigma$  which may be taken as  $\Sigma : z = 0 \pmod{2\pi}$ . The Poincare map  $M : \Sigma \rightarrow \Sigma$  is defined as follows: Let  $p$  be a point on  $\Sigma$ , and using it as an initial condition for the flow (163)-(165), let the resulting trajectory evolve in time until  $z = 2\pi$ , that is until it once again intersects  $\Sigma$ , this time at some point  $q$ . Then  $M$  maps  $p$  to  $q$ . Note that a fixed point of the Poincare map corresponds to a  $2\pi$ -periodic motion of the flow.

In the case of eqs.(163)-(165) when  $F = 0$ , we could still use this setup, even though in that case the system would be autonomous and the phase plane would be more appropriate. We use the three dimensional space instead, in order to draw conclusions about the  $F > 0$  case from the structure of the  $F = 0$  case. Thus when  $F = 0$ , the equilibria that would normally lie in the  $x$ - $y$  phase plane, now become closed loops in the  $R^2 \times S$  phase space, i.e. "periodic" orbits of period  $2\pi$ . If we now allow  $F$  to be non-zero, a continuity argument may be expected to yield that each of these periodic orbits continues to persist, giving rise to the conclusion that for each equilibrium point of the  $F = 0$  system, there is a  $2\pi$  periodic motion of the  $F > 0$  system, at least for small enough  $F$ . Such a periodic motion would be a limit cycle in the  $R^2 \times S$  phase space, and a fixed point in the Poincare map. The "continuity argument" is called *structural stability* and offers conditions under which this story holds true. The equilibria in the autonomous system must be *hyperbolic*, that is the linearized constant coefficient system valid in the neighborhood of a given equilibrium point must have no eigenvalues with zero real part.

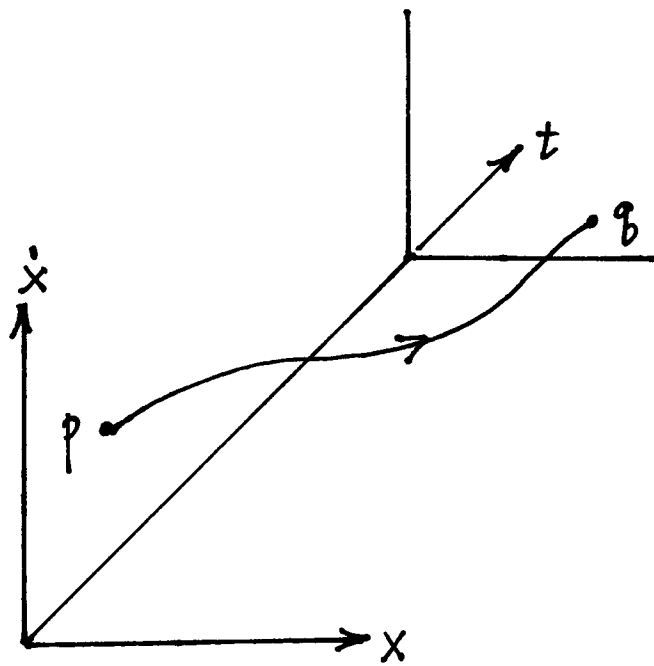

$$\Sigma: t = 2\pi \equiv 0 \pmod{2\pi}$$

flow

$$\Sigma: t = 0$$

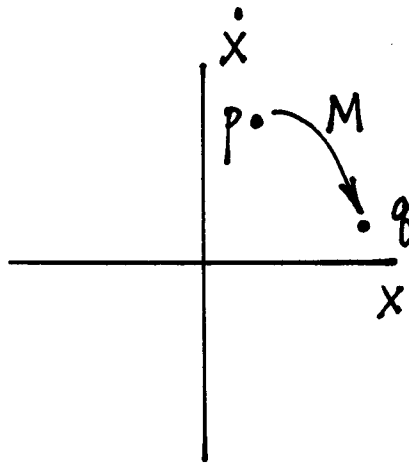

Poincaré map

$$M: p \mapsto q$$

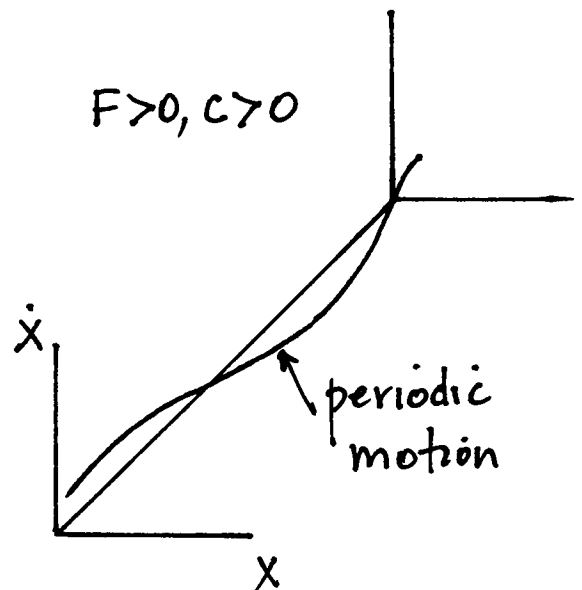
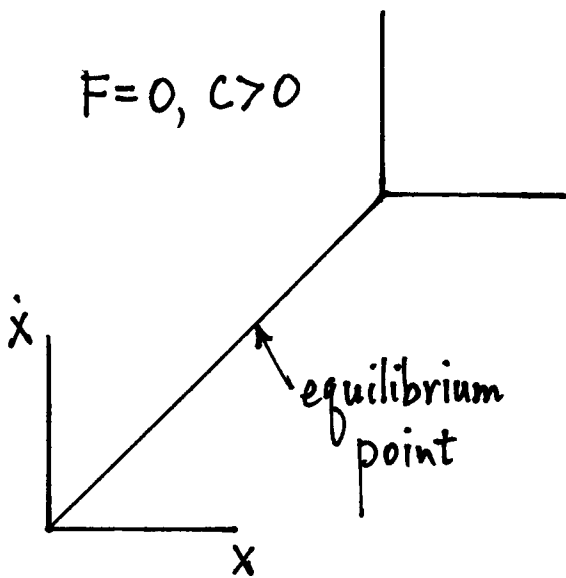

### 4.1 Two Variable Expansion Method

In this section we use a perturbation method to investigate the dynamics of eq.(162) for small values of  $\epsilon$ . We could use averaging for this purpose, but instead we use another method which is equivalent to first order averaging. The idea of the method is that the expected form of solution of many nonlinear vibration problems involves two time scales: the time scale of the periodic motion itself, and a slower time scale which represents the approach to the periodic motion. The method proposes to distinguish between these two time scales by associating a separate independent (time-like) variable with each one. We will use the notation that  $\xi$  represents stretched time  $\omega t$ , and  $\eta$  represents slow time  $\epsilon t$ :

$$\xi = \omega t, \quad \eta = \epsilon t \tag{166}$$

In order to substitute these definitions into the forced Duffing equation (162), we need expressions for the first and second derivatives of  $x$  with respect to  $t$ . We obtain these by using the chain rule:

$$\frac{dx}{dt} = \frac{\partial x}{\partial \xi} \frac{d\xi}{dt} + \frac{\partial x}{\partial \eta} \frac{d\eta}{dt} = \omega \frac{\partial x}{\partial \xi} + \epsilon \frac{\partial x}{\partial \eta} \tag{167}$$

$$\frac{d^2x}{dt^2} = \omega^2 \frac{\partial^2 x}{\partial \xi^2} + 2\omega\epsilon \frac{\partial^2 x}{\partial \xi \partial \eta} + \epsilon^2 \frac{\partial^2 x}{\partial \eta^2} \tag{168}$$

Substituting (167) and (168) into (162) gives the following *partial* differential equation:

$$\omega^2 \frac{\partial^2 x}{\partial \xi^2} + 2\omega\epsilon \frac{\partial^2 x}{\partial \xi \partial \eta} + \epsilon^2 \frac{\partial^2 x}{\partial \eta^2} + x + \epsilon c \left( \omega \frac{\partial x}{\partial \xi} + \epsilon \frac{\partial x}{\partial \eta} \right) + \epsilon \alpha x^3 = \epsilon F \cos \xi \tag{169}$$

Next we expand  $x$  and  $\omega$  in power series:

$$x(\xi, \eta) = x_0(\xi, \eta) + \epsilon x_1(\xi, \eta) + \dots, \quad \omega = 1 + k_1 \epsilon + \dots \tag{170}$$

Substituting (170) into (169) and neglecting terms of  $O(\epsilon^2)$ , gives, after collecting terms:

$$\frac{\partial^2 x_0}{\partial \xi^2} + x_0 = 0 \tag{171}$$

$$\frac{\partial^2 x_1}{\partial \xi^2} + x_1 = -2 \frac{\partial^2 x_0}{\partial \xi \partial \eta} - 2k_1 \frac{\partial^2 x_0}{\partial \xi^2} - c \frac{\partial x_0}{\partial \xi} - \alpha x_0^3 + F \cos \xi \tag{172}$$

We take the general solution to eq.(171) in the form:

$$x_0(\xi, \eta) = A(\eta) \cos \xi + B(\eta) \sin \xi \tag{173}$$

Note here that the “constants” of integration  $A, B$  are in fact arbitrary functions of slow time  $\eta$  since (171) is a p.d.e. Substituting (173) into (172) and simplifying the resulting trig terms, we obtain an equation of the form:

$$\frac{\partial^2 x_1}{\partial \xi^2} + x_1 = (\dots) \sin \xi + (\dots) \cos \xi + \text{nonresonant terms} \tag{174}$$

For no resonant terms, we require the coefficients of  $\sin \xi$  and  $\cos \xi$  to vanish, giving the following slow flow:

$$2\frac{dA}{d\eta} + cA + 2k_1B - \frac{3}{4}\alpha B(A^2 + B^2) = 0 \tag{175}$$

$$2\frac{dB}{d\eta} + cB - 2k_1A + \frac{3}{4}\alpha A(A^2 + B^2) = F \tag{176}$$

Equilibrium points of the slow flow (175),(176) correspond to periodic motions of the forced Duffing equation (162). To determine them, set  $\frac{dA}{d\eta}$  and  $\frac{dB}{d\eta}$  to zero. Multiplying (175) by  $A$  and adding it to (176) multiplied by  $B$  gives:

$$R^2c = BF, \quad \text{where } R^2 = A^2 + B^2 \tag{177}$$

Similarly, multiplying (175) by  $B$  and subtracting it from (176) multiplied by  $A$  gives:

$$-2k_1R^2 + \frac{3}{4}\alpha R^4 = AF \tag{178}$$

Squaring (177) and adding it to the square of (178) gives:

$$R^2 \left( c^2 + \left( -2k_1 + \frac{3}{4}\alpha R^2 \right)^2 \right) = F^2 \tag{179}$$

Eq.(179) may be solved for  $k_1$  which, with (170) gives the following relation between the response amplitude  $R$  and the frequency  $\omega$  of the periodic motion:

$$\omega = 1 + \frac{3}{8}\epsilon\alpha R^2 \pm \epsilon\frac{1}{2}\sqrt{\frac{F^2}{R^2} - c^2} \tag{180}$$

Note that if both the forcing  $F$  and the damping  $c$  are zero, then (180) gives  $\omega$  to be a single-valued function of  $R$ . If  $c = 0$  but  $F > 0$ , then (180) gives  $\omega$  to be a double-valued function of  $R$  which is valid for every  $R$ . On the other hand if both  $F > 0$  and  $c > 0$ , then (180) gives  $\omega$  to be a double-valued function of  $R$  which, however, is only valid for  $R < F/c$ .

The slow flow (175),(176) may also be used to determine the *stability* of these periodic motions (which correspond to slow flow equilibria). We do so in the special case of zero damping. Setting  $c = 0$  in (175),(176) we obtain:

$$\frac{dA}{d\eta} = -k_1B + \frac{3}{8}\alpha B(A^2 + B^2) \tag{181}$$

$$\frac{dB}{d\eta} = k_1A - \frac{3}{8}\alpha A(A^2 + B^2) + \frac{F}{2} \tag{182}$$

Eqs.(181),(182) have equilibria at

$$B = 0, \quad A = \pm R, \quad \text{where } k_1 = \frac{3}{8}\alpha R^2 \mp \frac{F}{2R} \tag{183}$$

where we use the convention that  $R > 0$ . In order to determine the stability of these equilibria, we set  $B = u$  and  $A = \pm R + v$  and linearize the resulting equations in  $u, v$ , giving:

$$\frac{dv}{d\eta} = \left(\frac{3}{8}\alpha R^2 - k_1\right) u, \quad \frac{du}{d\eta} = \left(-\frac{9}{8}\alpha R^2 + k_1\right) v \quad (184)$$

From eqs.(184) we see that the equilibrium is a center if

$$\left(\frac{3}{8}\alpha R^2 - k_1\right) \left(\frac{9}{8}\alpha R^2 - k_1\right) > 0 \quad (185)$$

If this same quantity is negative, the equilibrium is a saddle. Eq.(185) can be simplified by using (183) to eliminate  $k_1$ , giving that the equilibrium is a center if

$$\pm \frac{F}{2R} \left(\frac{3}{4}\alpha R^2 \pm \frac{F}{2R}\right) > 0 \quad (186)$$

Now let's consider each branch separately. For the upper sign,  $A = +R > 0$  and condition (186) is satisfied so that the equilibrium is a center. For the lower sign,  $A = -R < 0$  and condition (186) states that the equilibrium is a center if

$$\frac{3}{4}\alpha R^2 - \frac{F}{2R} < 0 \quad (187)$$

Eq.(187) can be simplified by using eq.(180), which in this case may be written

$$\omega = 1 + k_1\epsilon = 1 + \frac{3}{8}\epsilon\alpha R^2 + \frac{F\epsilon}{2R} \quad (188)$$

Differentiating (188) with respect to  $R$ , we obtain

$$\frac{d\omega}{dR} = \epsilon \left(\frac{3}{4}\alpha R - \frac{F}{2R^2}\right) \quad (189)$$

Comparison of (189) with (187) shows that the slow flow equilibrium point corresponding to the lower sign in eqs.(183) will be a center if  $\frac{d\omega}{dR} < 0$ , and a saddle if  $\frac{d\omega}{dR} > 0$ .

If we imagine the forcing frequency  $\omega$  to be varied quasistatically, then as it attains the value at which  $\frac{d\omega}{dR} = 0$ , a saddle-node bifurcation occurs in which the saddle and center (which have been shown to occur for parameters which satisfy eq.(188)) merge and disappear. The number of slow flow equilibria will have changed from three to one, and a motion which was circulating around the bifurcating center would now find itself circulating around the other center. If the system included some damping,  $c > 0$ , the centers would become stable spirals, and a motion which had been close to the bifurcating spiral would, after the bifurcation, find itself approaching the remaining spiral. This motion is known as *jump phenomenon*. Before the bifurcation, each of the stable spirals had its own *basin of attraction*, that is, its own set of initial conditions which would approach it as  $t \rightarrow \infty$ . As the bifurcation occurs, the basin of attraction of the bifurcating spiral disappears along with the spiral itself, and a motion originally in that basin of attraction



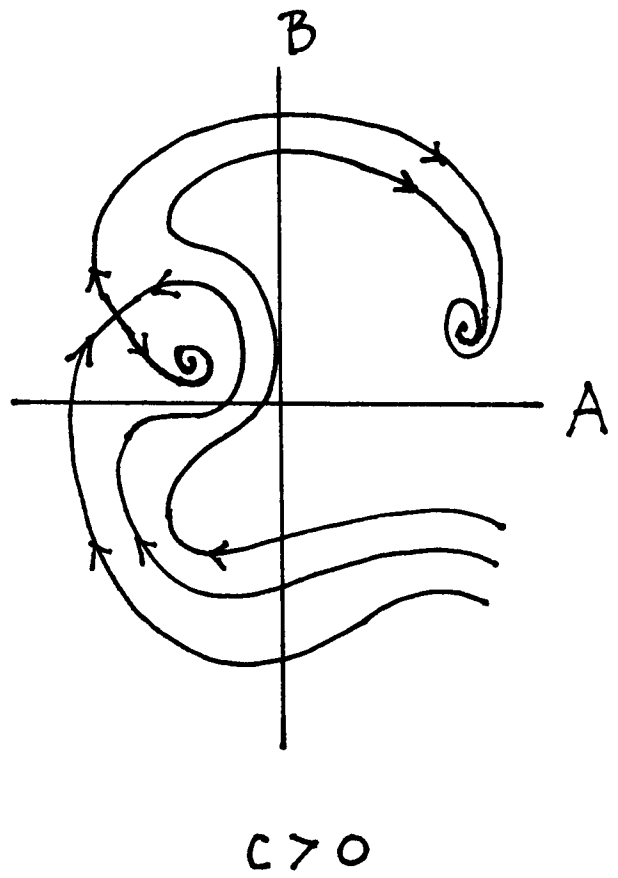
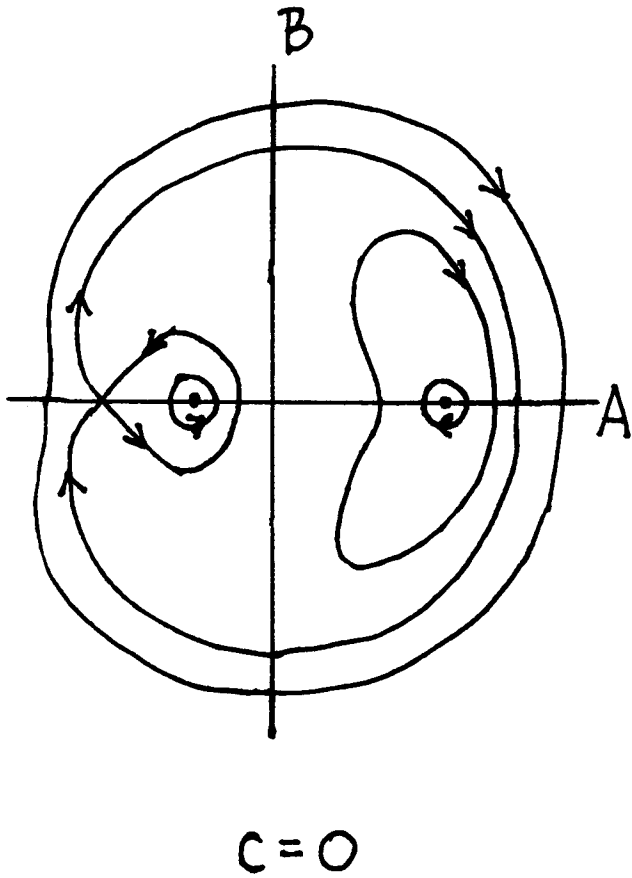
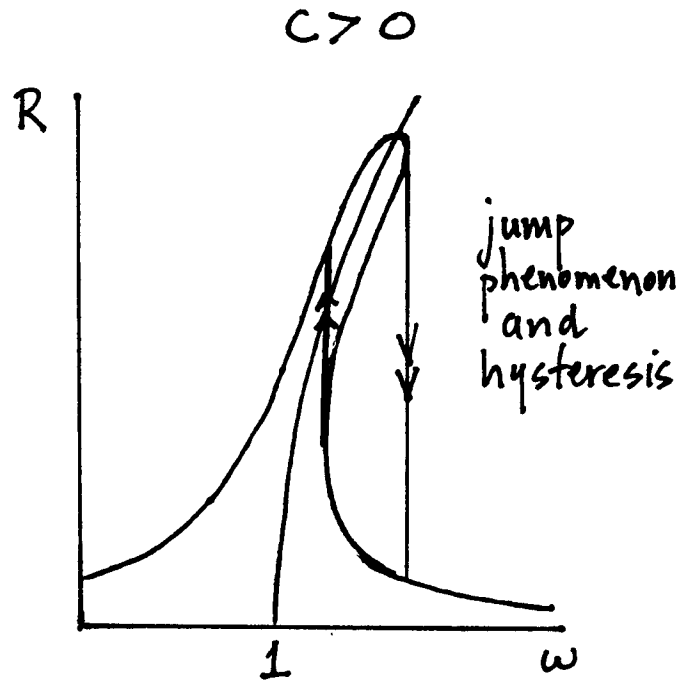
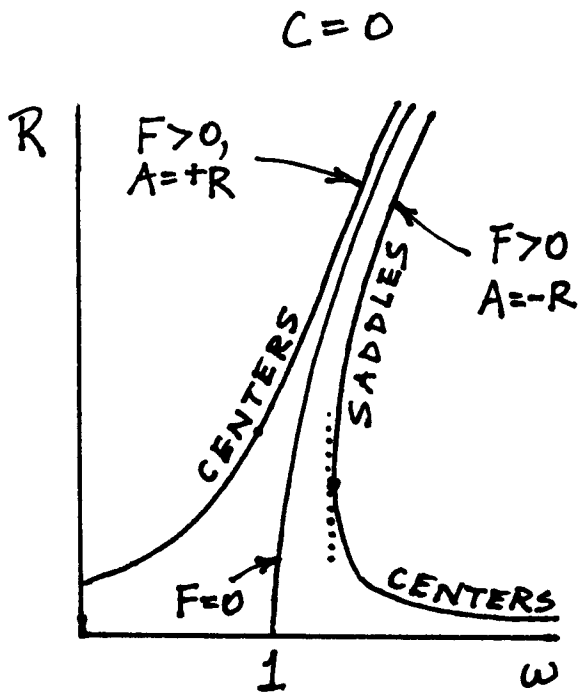

now finds itself in the basin of attraction of the remaining spiral. If the forcing frequency were now to reverse its course (again quasistatically), the bifurcation would occur in reverse and the saddle and spiral pair would be reborn, and with them the basin of attraction of the spiral would reappear. However, now the motion which was originally in the basin of attraction of the bifurcating spiral has been relocated into the basin of attraction of the other spiral, where it remains. When the value of  $\omega$  has returned to its original value, the motion in question will have moved from one basin of attraction to the other. This process is called *hysteresis*.

## 4.2 Cusp Catastrophe

The cusp catastrophe is a convenient way of describing a bifurcation sequence which occurs in many problems, including the forced undamped Duffing equation. Using the condition derived in the preceding section for equilibria of the slow flow (181),(182) in the case of no damping,  $c = 0$ , we write eq.(183) in the form:

$$k_1 = \frac{3}{8}\alpha A^2 - \frac{F}{2A} \quad (190)$$

Rearranging terms in (190) gives

$$\frac{8k_1}{3\alpha}A + \frac{4F}{3\alpha} = A^3 \quad (191)$$

which may be put into the standard form for the cusp catastrophe surface:

$$\lambda_1 X + \lambda_2 = X^3 \quad (192)$$

where

$$\lambda_1 = \frac{8k_1}{3\alpha}, \quad \lambda_2 = \frac{4F}{3\alpha}, \quad X = A \quad (193)$$

Note that the symbol  $X$  is a parameter here, unrelated to  $x$  in eq.(162). The intersection of the surface (192) with a plane  $\lambda_2 = \text{constant}$  is, in general, a pair of curves. This intersection is singular for  $\lambda_2 = 0$ , however, and the resulting curve is called a *pitchfork*.

The cusp in the cusp catastrophe comes about by asking for the curve in the  $\lambda_1$ - $\lambda_2$  plane which separates those points which have 3 real  $X$  values from those which have only 1. At such points eq.(192) will have a double root giving a total of 2 distinct real  $X$  values. The condition for a double root is that the partial derivative of (192) with respect to  $X$  must vanish, giving:

$$\lambda_1 = 3X^2 \quad (194)$$

Eliminating  $X$  between eqs.(194) and (192) gives the result:

$$\left(\frac{\lambda_1}{3}\right)^3 = \left(\frac{\lambda_2}{2}\right)^2 \quad (195)$$

Solving for  $\lambda_1$ , we get a  $2/3$  power law cusp.

# The Pitchfork

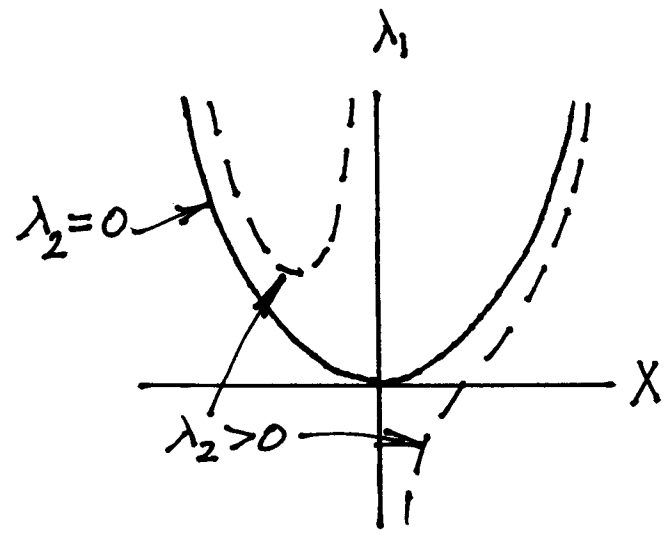

# The Cusp

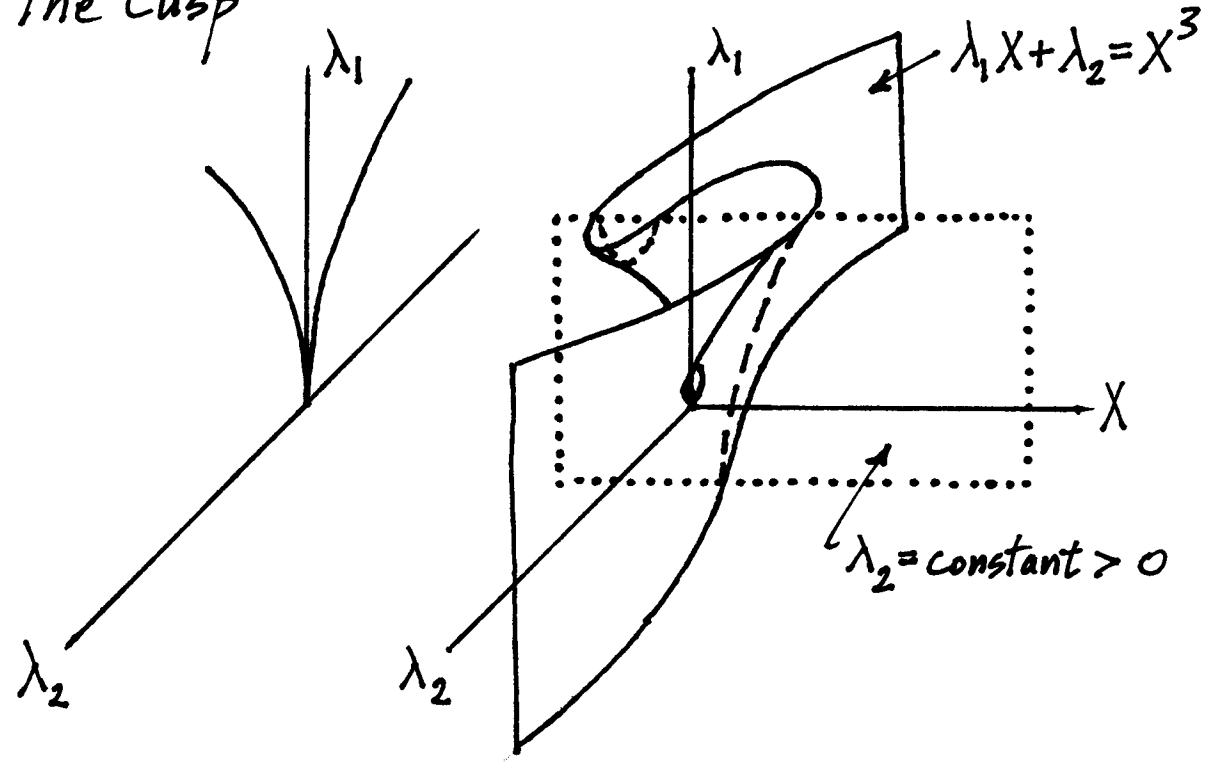

### 4.3 Problems

#### Problem 4.1

Subharmonic Resonance. We studied the forced Duffing oscillator in the form:

$$\frac{d^2x}{dt^2} + x + \epsilon c \frac{dx}{dt} + \epsilon \alpha x^3 = \epsilon F \cos \omega t, \quad \epsilon \ll 1 \quad (196)$$

This problem concerns what happens if the forcing is not small (sometimes called “hard excitation”):

$$\frac{d^2x}{dt^2} + x + \epsilon c \frac{dx}{dt} + \epsilon \alpha x^3 = F \cos \omega t, \quad \epsilon \ll 1 \quad (197)$$

Note that for small  $\epsilon$ , eq.(197) involves perturbing off of the forced harmonic oscillator, whereas eq.(196) perturbs off of the free harmonic oscillator.

Use the two variable expansion method on eq.(197) to show that to  $O(\epsilon)$ , the only resonant parameter values for  $\omega$  are  $\omega = 1, 3$  and  $1/3$ .

Then investigate the excitation of 3:1 subharmonics by setting

$$\omega = 3 + k_1 \epsilon, \quad \text{where } k_1 \text{ is a detuning parameter.} \quad (198)$$

Proceed as in the text to obtain a slow flow on the  $x_0$  coefficients  $A(\eta)$  and  $B(\eta)$ . Then transform to polar coordinates via  $A(\eta) = R(\eta) \cos \theta(\eta)$  and  $B(\eta) = R(\eta) \sin \theta(\eta)$ . Look for equilibria of the resulting slow flow, since these correspond to 3:1 subharmonics. Use the identity

$$\sin^2 3\theta + \cos^2 3\theta = 1$$

to eliminate  $\theta$  in order to find a relation between  $R^2$  and the parameters  $\alpha, c, F$  and  $k_1$  on a 3:1 subharmonic. For parameters  $\alpha = c = F = 1$ , solve for  $k_1$  and plot  $R$  versus  $k_1$ .

## 5 The Forced van der Pol Oscillator

The differential equation

$$\frac{d^2x}{dt^2} + x - \epsilon(1 - x^2)\frac{dx}{dt} = \epsilon F \cos \omega t \quad (199)$$

is called the forced van der Pol equation. It is a model for situations in which a system which is capable of self-oscillation is acted upon by another oscillator, in this case represented by the  $\epsilon F \cos \omega t$  term.

When a damped Duffing-type oscillator is driven with a periodic forcing function, we have seen that the result may be a periodic response at the same frequency as the forcing function. Since the unforced oscillation is dissipated due to the damping, we are not surprised to find that it is absent from the steady state forced behavior. In the case of a periodically forced limit cycle oscillator, however, we may expect that the steady state forced response might include both the unforced limit cycle oscillation as well as a response at the forcing frequency. If, however, the forcing is strong enough, and the frequency difference between the unforced limit cycle oscillation and the forcing function is small enough, then it may happen that the response occurs only at the forcing frequency. In this case the unforced oscillation is said to have been *quenched*, the forcing function is said to have *entrained* or *enslaved* the limit cycle oscillator, and the system is said to be *phase-locked* or *frequency-locked*, or just simply *locked*.

A biological application involves the human sleep-wake cycle, in which a person's biological clock is modeled by a van der Pol oscillator, and the daily night-day cycle caused by the earth's rotation is modeled as a periodic forcing term. Experiments have shown that the limit cycle of a person's biological clock typically has a period which is slightly different than 24 hours. Normal sleep patterns correspond to the entrainment of a person's biological clock by the 24 hour night-day forcing cycle. Insomnia and other sleep disorders may result if the limit cycle of the biological clock is not quenched, in which case we may expect a quasiperiodic response composed of both the limit cycle and forcing frequencies.

### 5.1 Entrainment

In this section we will use the two variable expansion method to derive a slow flow system which describes the dynamics of eq.(199) for small  $\epsilon$ . We replace time  $t$  by  $\xi = \omega t$  and  $\eta = \epsilon t$ , giving

$$\omega^2 \frac{\partial^2 x}{\partial \xi^2} + 2\omega \epsilon \frac{\partial^2 x}{\partial \xi \partial \eta} + \epsilon^2 \frac{\partial^2 x}{\partial \eta^2} + x - \epsilon(1 - x^2) \left( \omega \frac{\partial x}{\partial \xi} + \epsilon \frac{\partial x}{\partial \eta} \right) = \epsilon F \cos \xi \quad (200)$$

Next we expand  $x$  and  $\omega$  in power series:

$$x(\xi, \eta) = x_0(\xi, \eta) + \epsilon x_1(\xi, \eta) + \dots, \quad \omega = 1 + k_1 \epsilon + \dots \quad (201)$$

Note that the second of eqs.(201) means that we are restricting the following discussion to cases where the forcing frequency is nearly equal to the unforced limit cycle frequency, which is called

1:1 resonance. Substituting (201) into (200) and neglecting terms of  $O(\epsilon^2)$ , gives, after collecting terms:

$$\frac{\partial^2 x_0}{\partial \xi^2} + x_0 = 0 \tag{202}$$

$$\frac{\partial^2 x_1}{\partial \xi^2} + x_1 = -2 \frac{\partial^2 x_0}{\partial \xi \partial \eta} - 2k_1 \frac{\partial^2 x_0}{\partial \xi^2} + (1 - x_0^2) \frac{\partial x_0}{\partial \xi} + F \cos \xi \tag{203}$$

We take the general solution to eq.(202) in the form:

$$x_0(\xi, \eta) = A(\eta) \cos \xi + B(\eta) \sin \xi \tag{204}$$

Removing resonant terms, we obtain the following slow flow:

$$2 \frac{dA}{d\eta} = -2k_1 B + A - \frac{A}{4}(A^2 + B^2) \tag{205}$$

$$2 \frac{dB}{d\eta} = 2k_1 A + B - \frac{B}{4}(A^2 + B^2) + F \tag{206}$$

Eqs.(205),(206) can be simplified by using polar coordinates  $\rho$  and  $\theta$  in the  $A$ - $B$  slow flow phase plane:

$$A = \rho \cos \theta, \quad B = \rho \sin \theta \tag{207}$$

which produces the following expression for  $x_0$ , from (204):

$$x_0(\xi, \eta) = \rho(\eta) \cos(\xi - \theta(\eta)) \tag{208}$$

Substituting (207) into (205),(206) gives:

$$\frac{d\rho}{d\eta} = \frac{\rho}{8} (4 - \rho^2) + \frac{F}{2} \sin \theta \tag{209}$$

$$\frac{d\theta}{d\eta} = k_1 + \frac{F}{2\rho} \cos \theta \tag{210}$$

We seek equilibrium points of the slow flow (209),(210). These represent locked periodic motions of (199). Setting  $\frac{d\rho}{d\eta} = \frac{d\theta}{d\eta} = 0$ , solving for  $\sin \theta$  and  $\cos \theta$  and using  $\sin^2 \theta + \cos^2 \theta = 1$ , we obtain

$$F^2 = \rho^2 \left(1 - \frac{\rho^2}{4}\right)^2 + 4k_1^2 \rho^2 \tag{211}$$

Expanding eq.(211),

$$\frac{u^3}{16} - \frac{u^2}{2} + (4k_1^2 + 1)u - F^2 = 0 \tag{212}$$

where we have set  $u = \rho^2$  in order to simplify the algebraic expressions. Eq.(212) is a cubic polynomial in  $u$ , and application of Descartes' Rule of Signs gives, in view of its 3 sign changes, that it has either 3 positive roots, or 1 positive and two complex roots. The transition between

these two cases occurs when there is a repeated root, and the condition for this transition is that the partial derivative of (212) should vanish, which gives

$$\frac{3u^2}{16} - u + 1 + 4k_1^2 = 0 \tag{213}$$

Eliminating  $u$  between eqs.(213) and (212), we obtain:

$$\frac{F^4}{16} - \frac{F^2}{27}(1 + 36k_1^2) + \frac{16}{27}k_1^2(1 + 4k_1^2)^2 = 0 \tag{214}$$

Eq.(214) plots as two curves meeting at a cusp in the  $k_1$ - $F$  plane. As one of these curves is traversed quasistatically, a saddle-node bifurcation occurs. At the cusp, a further degeneracy occurs and there is a triply repeated root. The condition for this is that the partial derivative of (213) should vanish, which gives

$$\frac{3u}{8} - 1 = 0 \tag{215}$$

Substituting  $u = \frac{8}{3}$  into (213) and (212) gives the location of the cusp as:

$$k_1 = \frac{1}{\sqrt{12}} \approx 0.288, \quad F = \sqrt{\frac{32}{27}} \approx 1.088 \tag{216}$$

Before we can conclude that the perturbation analysis predicts that the forced van der Pol equation (199) supports entrainment, we must investigate the *stability* of the slow flow equilibria. Let  $(\rho_0, \theta_0)$  be an equilibrium solution of eqs.(209),(210). To determine its stability, we set

$$\rho = \rho_0 + v, \quad \theta = \theta_0 + w \tag{217}$$

where  $v$  and  $w$  are small deviations from equilibrium. Substituting (217) into (209),(210) and linearizing in  $v$  and  $w$  gives the constant coefficient system:

$$\frac{dv}{d\eta} = \frac{v}{2} - \frac{3}{8}\rho_0^2 v + \frac{F}{2} \cos \theta_0 w \tag{218}$$

$$\frac{dw}{d\eta} = -\frac{F}{2\rho_0^2} \cos \theta_0 v - \frac{F}{2\rho_0} \sin \theta_0 w \tag{219}$$

Eqs.(218),(219) may be simplified by using the following expressions from (209),(210) at equilibrium:

$$\frac{F}{2} \sin \theta_0 = -\frac{\rho_0}{2} + \frac{\rho_0^3}{8}, \quad \frac{F}{2} \cos \theta_0 = -k_1 \rho_0 \tag{220}$$

Thus stability is determined by the eigenvalues of the following matrix  $M$ :

$$M = \begin{bmatrix} \frac{1}{2} - \frac{3}{8}\rho_0^2 & -k_1 \rho_0 \\ \frac{k_1}{\rho_0} & \frac{1}{2} - \frac{1}{8}\rho_0^2 \end{bmatrix} \tag{221}$$

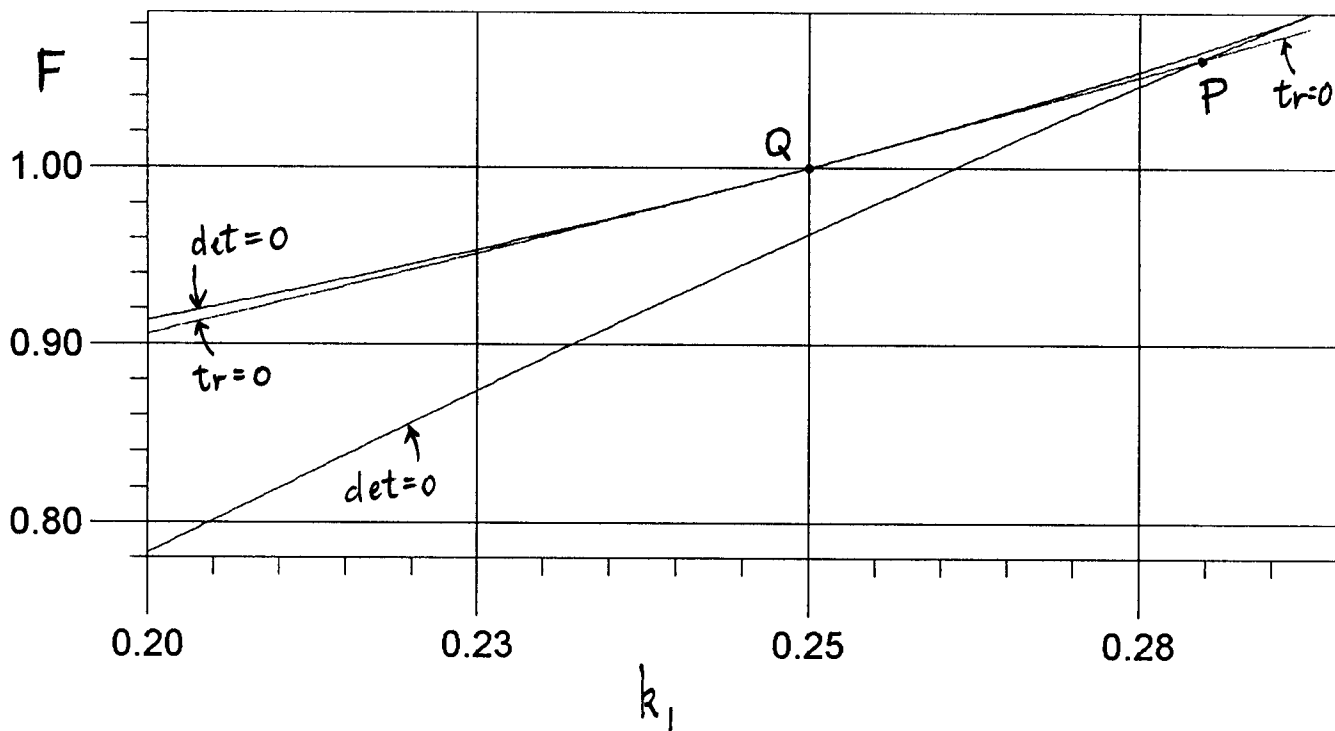
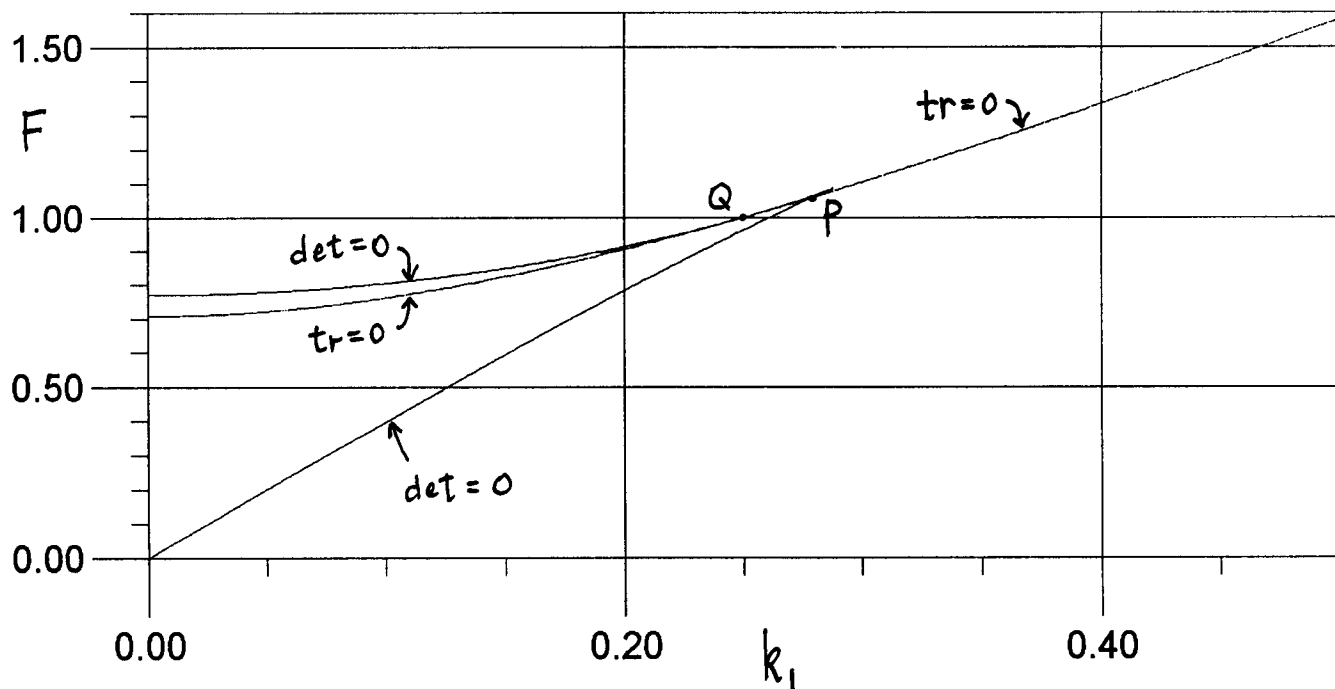



The trace and determinant of  $M$  are given by:

$$\operatorname{tr}(M) = 1 - \frac{\rho_0^2}{2}, \quad \det(M) = \left(-\frac{1}{2} + \frac{3}{8}\rho_0^2\right) \left(-\frac{1}{2} + \frac{1}{8}\rho_0^2\right) + k_1^2 \quad (222)$$

The eigenvalues  $\lambda$  of  $M$  satisfy the characteristic equation:

$$\lambda^2 - \operatorname{tr}(M) \lambda + \det(M) = 0 \quad (223)$$

For stability, the eigenvalues of  $M$  must have negative real parts. This requires that  $\operatorname{tr}(M) < 0$  and  $\det(M) > 0$ , which become, using the notation  $u = \rho_0^2$ :

$$\operatorname{tr}(M) = 1 - \frac{u}{2} < 0, \quad \det(M) = \frac{1}{4} \left( \frac{3u^2}{16} - u + 1 + 4k_1^2 \right) > 0 \quad (224)$$

Comparison of this expression for  $\det(M)$  and eq.(213) shows that  $\det(M)$  vanishes on the curves (214) along which there are saddle-node bifurcations. This illustrates a very typical phenomenon that characterizes nonlinear vibrations, namely that *a change in stability is accompanied by a bifurcation*. (This is not true of linear systems, in which a change in stability *cannot* be accompanied by a bifurcation.)

The condition (224) on the trace( $M$ ) requires that  $u > 2$  for stability. Substituting  $u = 2$  in (212), we obtain

$$F^2 = \frac{1}{2} + 8k_1^2 \quad (225)$$

Hopf bifurcations occur along the curve represented by eq.(225) (assuming  $\det(M) > 0$ ).

This curve (225) intersects the lower curve of saddle-node bifurcations, eq.(214), at a point we shall refer to as point  $P$ , and it intersects and is tangent to the upper curve of saddle-node bifurcations at a point we shall refer to as point  $Q$ :

$$P : k_1 = \frac{\sqrt{5}}{8} \approx 0.279, \quad F = \frac{3}{\sqrt{8}} \approx 1.060, \quad Q : k_1 = \frac{1}{4} = 0.25, \quad F = 1 \quad (226)$$

It turns out that the perturbation analysis predicts that the forced van der Pol equation (199) exhibits stable entrainment solutions everywhere in the first quadrant of the  $k_1$ - $F$  parameter plane *except* in that region bounded by (i) the lower curve of saddle-node bifurcations, eq.(214), from the origin to the point  $P$ , (ii) the curve of Hopf bifurcations, eq.(225), from point  $P$  to infinity, and (iii) the  $k_1$  axis. In physical terms this means that *for a given detuning  $k_1$ , there is a minimum value of forcing  $F$  required in order for entrainment to occur*. Moreover, as the detuning  $k_1$  gets larger, entrainment requires a larger forcing amplitude  $F$ . Also note that since  $k_1$  always appears in the form  $k_1^2$  in the equations of the bifurcation and stability curves, the above conclusions are invariant under a change of sign of  $k_1$ , that is, they are independent of whether we are above or below the 1:1 resonance. (See “Nonlinear Oscillations, Dynamical Systems, and Bifurcations of Vector Fields” by J.Guckenheimer and P.Holmes, Springer Verlag, 1983, pp.70-74 for a more detailed analysis of the bifurcations involved in this problem.)

# Forced van der Pol oscillator

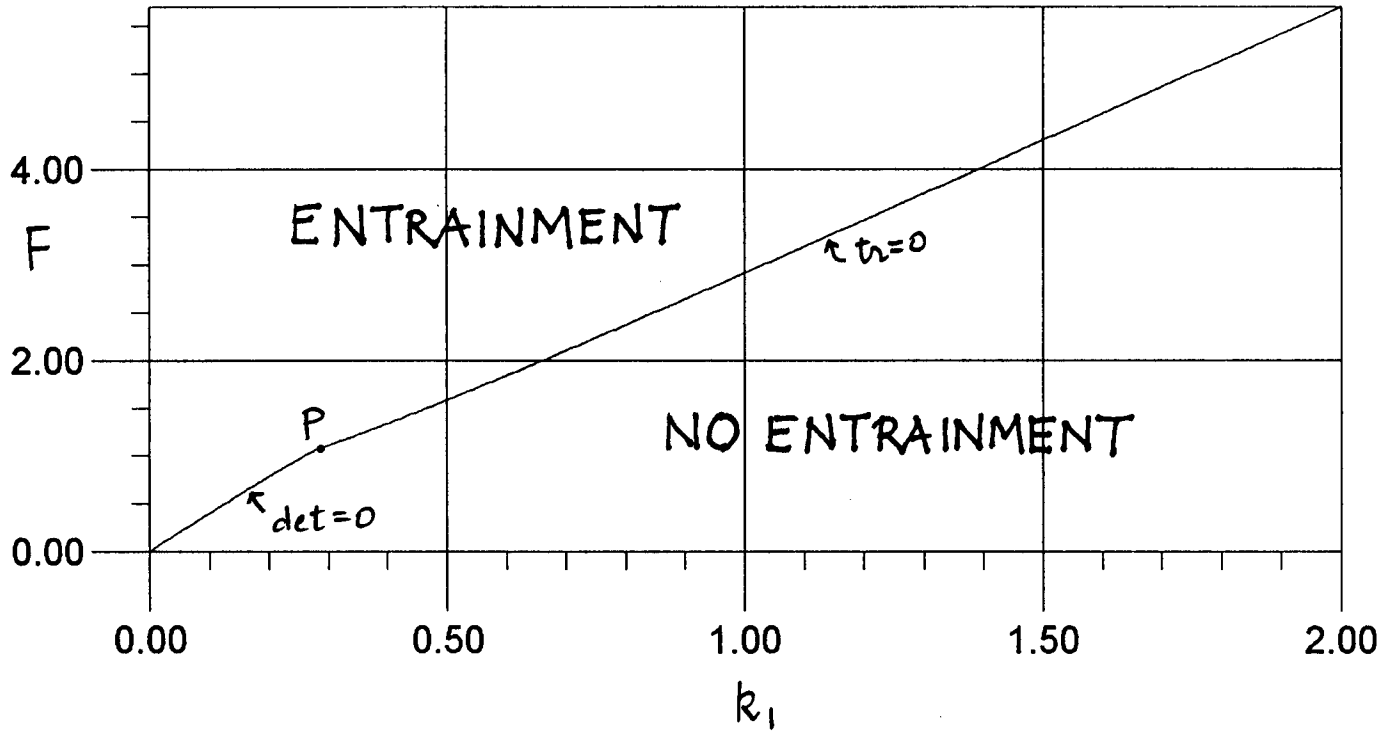

## 5.2 Problems

### Problem 5.1

In this Chapter we have displayed the bifurcation curves in the  $k_1$ - $F$  parameter plane. Many texts display the equivalent results as plots in the  $k_1$ - $u$  plane, with  $F$  fixed. In order for you to be familiar with this representation of the problem, do the following:

- a. Plot the curves  $\text{tr}(M)=0$  and  $\text{det}(M)=0$  in the  $k_1^2$ - $u$  plane for  $0 < k_1^2 < 0.2$  and  $0 < u < 5$ . Label stable regions S and unstable regions U.
- b. On this same plot, show the slow flow equilibrium condition (212) with  $F = 1$ .

## 6 Mathieu's Equation

The differential equation

$$\frac{d^2x}{dt^2} + (\delta + \epsilon \cos t) x = 0 \quad (227)$$

is called Mathieu's equation. It is a linear differential equation with variable (periodic) coefficients. It commonly occurs in nonlinear vibration problems in two different ways: (i) in systems in which there is periodic forcing, and (ii) in stability studies of periodic motions in nonlinear *autonomous* systems.

As an example of (i), take the case of a pendulum whose support is periodically forced in a vertical direction. The governing differential equation is

$$\frac{d^2x}{dt^2} + \left( \frac{g}{L} - \frac{A\omega^2}{L} \cos \omega t \right) \sin x = 0 \quad (228)$$

where the vertical motion of the support is  $A \cos \omega t$ , and where  $g$  is the acceleration of gravity,  $L$  is the pendulum's length, and  $x$  is its angle of deflection. In order to investigate the stability of one of the equilibrium solutions  $x = 0$  or  $x = \pi$ , we would linearize (228) about the desired equilibrium, giving, after suitable rescaling of time, an equation of the form of (227).

As an example of (ii), we consider a system known as "the particle in the plane". This consists of a particle of unit mass which is constrained to move in the  $x$ - $y$  plane, and is restrained by two linear springs, each with spring constant of  $\frac{1}{2}$ . The anchor points of the two springs are located on the  $x$  axis at  $x = 1$  and  $x = -1$ . Each of the two springs has unstretched length  $L$ . This autonomous two degree of freedom system exhibits an exact solution corresponding to a mode of vibration in which the particle moves along the  $x$  axis:

$$x = A \cos t, \quad y = 0 \quad (229)$$

In order to determine the stability of this motion, one must first derive the equations of motion, then substitute  $x = A \cos t + u$ ,  $y = 0 + v$ , where  $u$  and  $v$  are small deviations from the motion (229), and then linearize in  $u$  and  $v$ . The result is two linear differential equations on  $u$  and  $v$ . The  $u$  equation turns out to be the simple harmonic oscillator, and cannot produce instability. The  $v$  equation is:

$$\frac{d^2v}{dt^2} + \left( \frac{1 - L - A^2 \cos^2 t}{1 - A^2 \cos^2 t} \right) v = 0 \quad (230)$$

Expanding (230) for small  $A$  and setting  $\tau = 2t$ , we obtain

$$\frac{d^2v}{d\tau^2} + \left( \frac{2 - 2L - A^2L}{8} - \frac{A^2L}{8} \cos \tau + O(A^4) \right) v = 0 \quad (231)$$

which is, to  $O(A^4)$ , in the form of Mathieu's eq.(227) with  $\delta = \frac{2 - 2L - A^2L}{8}$  and  $\epsilon = -\frac{A^2L}{8}$ .

The chief concern with regard to Mathieu's equation is whether or not all solutions are bounded for given values of the parameters  $\delta$  and  $\epsilon$ . If all solutions are bounded then the corresponding point in the  $\delta$ - $\epsilon$  parameter plane is said to be stable. A point is called unstable if an unbounded solution exists.

# The particle in the plane

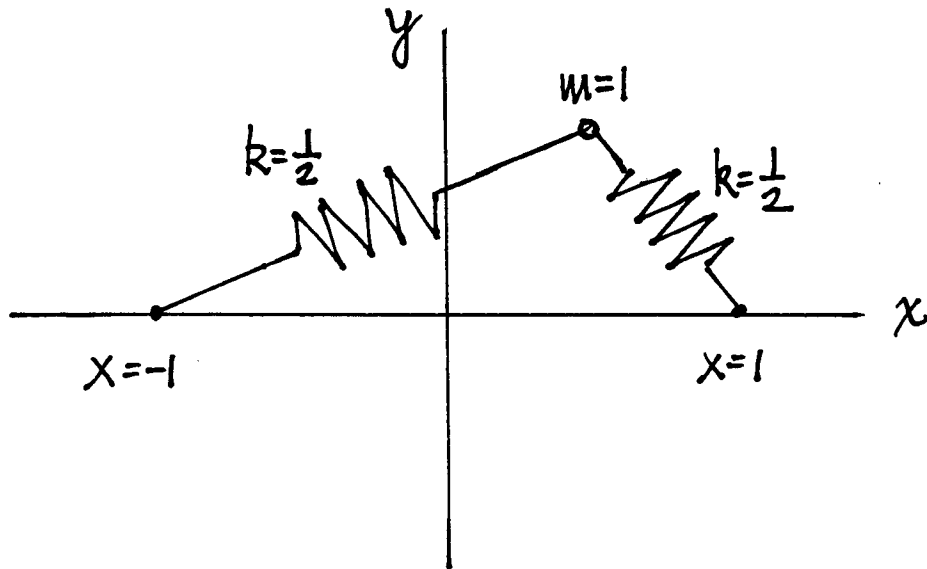

$$\frac{d^2x}{dt^2} + f_1(x, y) (x + 1) + f_2(x, y) (x - 1) = 0$$

$$\frac{d^2y}{dt^2} + f_1(x, y) y + f_2(x, y) y = 0$$

$$f_1(x, y) = \frac{1}{2} \left( 1 - \frac{L}{\sqrt{(1+x)^2 + y^2}} \right)$$

$$f_2(x, y) = \frac{1}{2} \left( 1 - \frac{L}{\sqrt{(1-x)^2 + y^2}} \right)$$

### 6.1 Perturbations

In this section we will use the two variable expansion method to look for a general solution to Mathieu's eq.(227) for small  $\epsilon$ . Since (227) is linear, there is no need to stretch time, and we set  $\xi = t$  and  $\eta = \epsilon t$ , giving

$$\frac{\partial^2 x}{\partial \xi^2} + 2\epsilon \frac{\partial^2 x}{\partial \xi \partial \eta} + \epsilon^2 \frac{\partial^2 x}{\partial \eta^2} + (\delta + \epsilon \cos \xi) x = 0 \tag{232}$$

Next we expand  $x$  in a power series:

$$x(\xi, \eta) = x_0(\xi, \eta) + \epsilon x_1(\xi, \eta) + \dots \tag{233}$$

Substituting (233) into (227) and neglecting terms of  $O(\epsilon^2)$ , gives, after collecting terms:

$$\frac{\partial^2 x_0}{\partial \xi^2} + \delta x_0 = 0 \tag{234}$$

$$\frac{\partial^2 x_1}{\partial \xi^2} + \delta x_1 = -2 \frac{\partial^2 x_0}{\partial \xi \partial \eta} - x_0 \cos \xi \tag{235}$$

We take the general solution to eq.(234) in the form:

$$x_0(\xi, \eta) = A(\eta) \cos \sqrt{\delta} \xi + B(\eta) \sin \sqrt{\delta} \xi \tag{236}$$

Substituting (236) into (235), we obtain

$$\begin{aligned} \frac{\partial^2 x_1}{\partial \xi^2} + \delta x_1 = & 2\sqrt{\delta} \frac{dA}{d\eta} \sin \sqrt{\delta} \xi - 2\sqrt{\delta} \frac{dB}{d\eta} \cos \sqrt{\delta} \xi \\ & - A \cos \sqrt{\delta} \xi \cos \xi - B \sin \sqrt{\delta} \xi \cos \xi \end{aligned} \tag{237}$$

Using some trig identities, this becomes

$$\begin{aligned} \frac{\partial^2 x_1}{\partial \xi^2} + \delta x_1 = & 2\sqrt{\delta} \frac{dA}{d\eta} \sin \sqrt{\delta} \xi - 2\sqrt{\delta} \frac{dB}{d\eta} \cos \sqrt{\delta} \xi \\ & - \frac{A}{2} (\cos(\sqrt{\delta} + 1)\xi + \cos(\sqrt{\delta} - 1)\xi) \\ & - \frac{B}{2} (\sin(\sqrt{\delta} + 1)\xi + \sin(\sqrt{\delta} - 1)\xi) \end{aligned} \tag{238}$$

For a general value of  $\delta$ , removal of resonance terms gives the trivial slow flow:

$$\frac{dA}{d\eta} = 0, \quad \frac{dB}{d\eta} = 0 \tag{239}$$

This means that for general  $\delta$ , the  $\cos t$  driving term in Mathieu's eq.(227) has no effect. However, if we choose  $\delta = \frac{1}{4}$ , eq.(238) becomes

$$\begin{aligned} \frac{\partial^2 x_1}{\partial \xi^2} + \frac{1}{4} x_1 = & \frac{dA}{d\eta} \sin \frac{\xi}{2} - \frac{dB}{d\eta} \cos \frac{\xi}{2} \\ & - \frac{A}{2} \left( \cos \frac{3\xi}{2} + \cos \frac{\xi}{2} \right) \\ & - \frac{B}{2} \left( \sin \frac{3\xi}{2} - \sin \frac{\xi}{2} \right) \end{aligned} \tag{240}$$

Now removal of resonance terms gives the slow flow:

$$\frac{dA}{d\eta} = -\frac{B}{2}, \quad \frac{dB}{d\eta} = -\frac{A}{2} \quad \Rightarrow \quad \frac{d^2A}{d\eta^2} = \frac{A}{4} \quad (241)$$

Thus  $A(\eta)$  and  $B(\eta)$  involve exponential growth, and the parameter value  $\delta = \frac{1}{4}$  causes instability. This corresponds to a 2:1 subharmonic resonance in which the driving frequency is twice the natural frequency.

This discussion may be generalized by “detuning” the resonance, that is, by expanding  $\delta$  in a power series in  $\epsilon$ :

$$\delta = \frac{1}{4} + \delta_1\epsilon + \delta_2\epsilon^2 + \dots \quad (242)$$

Now eq.(235) gets an additional term:

$$\frac{\partial^2 x_1}{\partial \xi^2} + \frac{1}{4} x_1 = -2 \frac{\partial^2 x_0}{\partial \xi \partial \eta} - x_0 \cos \xi - \delta_1 x_0 \quad (243)$$

which results in the following additional terms in the slow flow eqs.(241):

$$\frac{dA}{d\eta} = \left(\delta_1 - \frac{1}{2}\right) B, \quad \frac{dB}{d\eta} = -\left(\delta_1 + \frac{1}{2}\right) A \quad \Rightarrow \quad \frac{d^2A}{d\eta^2} + \left(\delta_1^2 - \frac{1}{4}\right) A = 0 \quad (244)$$

Here we see that  $A(\eta)$  and  $B(\eta)$  will be sine and cosine functions of slow time  $\eta$  if  $\delta_1^2 - \frac{1}{4} > 0$ , that is, if either  $\delta_1 > \frac{1}{2}$  or  $\delta_1 < -\frac{1}{2}$ . Thus the following two curves in the  $\delta$ - $\epsilon$  plane represent stability changes, and are called *transition curves*:

$$\delta = \frac{1}{4} \pm \frac{\epsilon}{2} + O(\epsilon^2) \quad (245)$$

These two curves emanate from the point  $\delta = \frac{1}{4}$  on the  $\delta$  axis and define a region of instability called a *tongue*. Inside the tongue, for small  $\epsilon$ ,  $x$  grows exponentially in time. Outside the tongue, from (236) and (244),  $x$  is the sum of terms each of which is the product of two periodic (sinusoidal) functions with generally incommensurate frequencies, that is,  $x$  is a quasiperiodic function of  $t$ .

## 6.2 Floquet Theory

In this section we present Floquet theory, that is, the general theory of linear differential equations with periodic coefficients. Our goal is to apply this theory to Mathieu’s equation (227).

Let  $x$  be an  $n \times 1$  column vector, and let  $A$  be an  $n \times n$  matrix with time-varying coefficients which have period  $T$ . Floquet theory is concerned with the following system of first order differential equations:

$$\frac{dx}{dt} = A(t) x, \quad A(t+T) = A(t) \quad (246)$$

# MATHIEU'S EQUATION

$\epsilon$

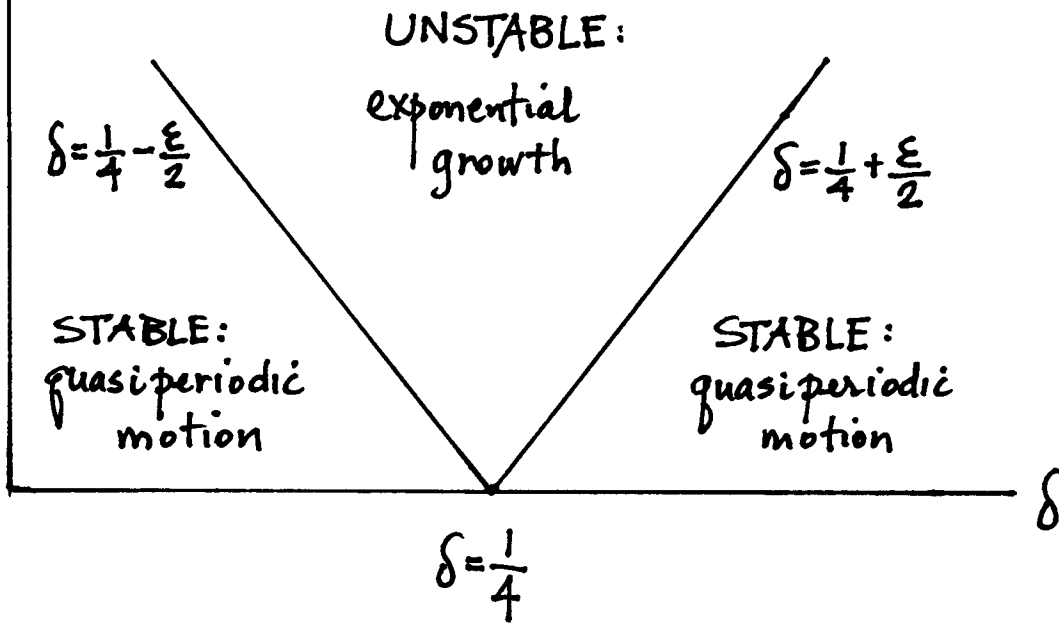



Notice that if the independent variable  $t$  is replaced by  $t + T$ , the system (246) remains invariant. This means that if  $x(t)$  is a solution (vector) of (246), and if in the vector function  $x(t)$ ,  $t$  is replaced everywhere by  $t + T$ , then new vector,  $x(t + T)$ , which in general will be completely different from  $x(t)$ , is also a solution of (246). This observation may be stated conveniently in terms of fundamental solution matrices.

Let  $X(t)$  be a fundamental solution matrix of (246).  $X(t)$  is then an  $n \times n$  matrix, with each of its columns consisting of a linearly independent solution vector of (246). In particular, we choose the  $i^{th}$  column vector to satisfy an initial condition for which each of the scalar components of  $x(0)$  is zero, except for the  $i^{th}$  scalar component of  $x(0)$ , which is unity. This gives  $X(0) = I$ , where  $I$  is the  $n \times n$  identity matrix. Since the columns of  $X(t)$  are linearly independent, they form a basis for the  $n$ -dimensional solution space of (246), and thus any other fundamental solution matrix  $Z(t)$  may be written in the form  $Z(t) = X(t) C$ , where  $C$  is a nonsingular  $n \times n$  matrix. This means that each of the columns of  $Z(t)$  may be written as a linear combination of the columns of  $X(t)$ .

From our previous observations, replacing  $t$  by  $t + T$  in  $X(t)$  produces a new fundamental solution matrix  $X(t + T)$ . Each of the columns of  $X(t + T)$  may be written as a linear combination of the columns of  $X(t)$ , so that

$$X(t + T) = X(t) C \tag{247}$$

Note that at  $t = 0$ , (247) becomes  $X(T) = X(0)C = IC = C$ , that is,

$$C = X(T) \tag{248}$$

Eq.(248) says that the matrix  $C$  (about which we know nothing up to now) is in fact equal to the value of the fundamental solution matrix  $X(t)$  evaluated at time  $T$ , that is, after one forcing period. Thus  $C$  could be obtained by numerically integrating (246) from  $t = 0$  to  $t = T$ ,  $n$  times, once for each of the  $n$  initial conditions satisfied by the  $i^{th}$  column of  $X(0)$ .

Eq.(247) is a key equation here. It has replaced the original system of o.d.e.'s with an iterative equation. For example, if we were to consider eq.(247) for the set of  $t$  values  $t = 0, T, 2T, 3T, \dots$ , we would be generating the successive iterates of a Poincare map corresponding to the surface of section  $\Sigma : t = 0 \pmod{2\pi}$ . This immediately gives the result that  $X(nT) = C^n$ , which shows that the question of the boundedness of solutions is intimately connected to the matrix  $C$ .

In order to solve eq.(247), we transform to normal coordinates. Let  $Y(t)$  be another fundamental solution matrix, as yet unknown. Each of the columns of  $Y(t)$  may be written as a linear combination of the columns of  $X(t)$ :

$$Y(t) = X(t) R \tag{249}$$

where  $R$  is an as yet unknown  $n \times n$  nonsingular matrix. Combining eqs.(247) and (249), we obtain

$$Y(t + T) = Y(t) R^{-1}CR \tag{250}$$

Now let us suppose that the matrix  $C$  has  $n$  linearly independent eigenvectors. If we choose the columns of  $R$  as these  $n$  eigenvectors, then the matrix product  $R^{-1}CR$  will be a diagonal

matrix with the eigenvalues  $\lambda_i$  of  $C$  on its main diagonal. With  $R^{-1}CR$  diagonal, the matrix  $Y(t)$  satisfying (250) will also be diagonal. This can be shown by construction: Let  $y_i(t)$  represent the  $i^{th}$  scalar component on the main diagonal of  $Y(t)$ . Then assuming  $Y(t)$  is diagonal, (250) can be written:

$$y_i(t + T) = \lambda_i y_i(t) \tag{251}$$

Eq.(251) is a linear functional equation. Let us look for a solution to it in the form

$$y_i(t) = \lambda_i^{kt} p_i(t) \tag{252}$$

where  $k$  is an unknown constant and  $p_i(t)$  is an unknown function. Substituting (252) into (251) gives:

$$y_i(t + T) = \lambda_i^{k(t+T)} p_i(t + T) = \lambda_i(\lambda_i^{kt} p_i(t)) = \lambda_i y_i(t) \tag{253}$$

Eq.(253) is satisfied if we take  $k = 1/T$  and  $p_i(t)$  a periodic function of period  $T$ :

$$y_i(t) = \lambda_i^{t/T} p_i(t), \quad p_i(t + T) = p_i(t) \tag{254}$$

Here eq.(254) is the general solution to eq.(251). The arbitrary periodic function  $p_i(t)$  plays the same role here that an arbitrary constant plays in the case of a linear first order o.d.e.

Since we are interested in the question of boundedness of solutions, we can see from eq.(254) that if  $|\lambda_i| > 1$ , then  $y_i \rightarrow \infty$  as  $t \rightarrow \infty$ , whereas if  $|\lambda_i| < 1$ , then  $y_i \rightarrow 0$  as  $t \rightarrow \infty$ . Thus we see that the original system (246) will be stable (all solutions bounded) if every eigenvalue  $\lambda_i$  of  $C = X(T)$  has modulus less than unity. If any one eigenvalue  $\lambda_i$  has modulus greater than unity, then (246) will be unstable (an unbounded solution exists).

Note that our assumption that  $C$  has  $n$  linearly independent eigenvectors could be relaxed, in which case we would have to deal with Jordan canonical form. The reader is referred to "Asymptotic Behavior and Stability Problems in Ordinary Differential Equations" by L.Cesari, Springer Verlag, 1963, section 4.1 for a complete discussion of this case.

### 6.3 Hill's Equation

In this section we apply Floquet theory to a generalization of Mathieu's equation (227), called Hill's equation:

$$\frac{d^2x}{dt^2} + f(t) x = 0, \quad f(t + T) = f(t) \tag{255}$$

Here  $x$  and  $f$  are scalars, and  $f(t)$  represents a general periodic function with period  $T$ . Eq.(255) includes examples such as eq.(230).

We begin by defining  $x_1 = x$  and  $x_2 = \frac{dx}{dt}$  so that (255) can be written as a system of two first order o.d.e.'s:

$$\frac{d}{dt} \begin{bmatrix} x_1 \\ x_2 \end{bmatrix} = \begin{bmatrix} 0 & 1 \\ -f(t) & 0 \end{bmatrix} \begin{bmatrix} x_1 \\ x_2 \end{bmatrix} \tag{256}$$

Next we construct a fundamental solution matrix out of two solution vectors,  $\begin{bmatrix} x_{11}(t) \\ x_{12}(t) \end{bmatrix}$  and  $\begin{bmatrix} x_{21}(t) \\ x_{22}(t) \end{bmatrix}$ , which satisfy the initial conditions:

$$\begin{bmatrix} x_{11}(0) \\ x_{12}(0) \end{bmatrix} = \begin{bmatrix} 1 \\ 0 \end{bmatrix}, \quad \begin{bmatrix} x_{21}(0) \\ x_{22}(0) \end{bmatrix} = \begin{bmatrix} 0 \\ 1 \end{bmatrix} \quad (257)$$

As we saw in the previous section, the matrix  $C$  is the evaluation of the fundamental solution matrix at time  $T$ :

$$C = \begin{bmatrix} x_{11}(T) & x_{21}(T) \\ x_{12}(T) & x_{22}(T) \end{bmatrix} \quad (258)$$

From Floquet theory we know that stability is determined by the eigenvalues of  $C$ :

$$\lambda^2 - (\text{tr}C)\lambda + \det C = 0 \quad (259)$$

where  $\text{tr}C$  and  $\det C$  are the trace and determinant of  $C$ . Now Hill's eq.(255) has the special property that  $\det C=1$ . This may be shown by defining  $W$  (the Wronskian) as:

$$W(t) = \det C = x_{11}(t) x_{22}(t) - x_{12}(t) x_{21}(t) \quad (260)$$

Taking the time derivative of  $W$  and using eq.(256) gives that  $\frac{dW}{dt} = 0$ , which implies that  $W(t) = \text{constant} = W(0) = 1$ . Thus eq.(259) can be written:

$$\lambda^2 - (\text{tr}C)\lambda + 1 = 0 \quad (261)$$

which has the solution:

$$\lambda = \frac{\text{tr}C \pm \sqrt{\text{tr}C^2 - 4}}{2} \quad (262)$$

Floquet theory showed that instability results if either eigenvalue has modulus larger than unity.

Thus if  $|\text{tr}C| > 2$ , then (262) gives real roots. But the product of the roots is unity, so if one root has modulus less than unity, the other has modulus greater than unity, with the result that this case is UNSTABLE and corresponds to exponential growth in time.

On the other hand, if  $|\text{tr}C| < 2$ , then (262) gives a pair of complex conjugate roots. But since their product must be unity, they must both lie on the unit circle, with the result that this case is STABLE. Note that the stability here is neutral stability not asymptotic stability, since Hill's eq.(255) has no damping. This case corresponds to quasiperiodic behavior in time.

Thus the transition from stable to unstable corresponds to those parameter values which give  $|\text{tr}C| = 2$ . From (262), if  $\text{tr}C = 2$  then  $\lambda = 1, 1$ , and from eq.(254) this corresponds to a periodic solution with period  $T$ . On the other hand, if  $\text{tr}C = -2$  then  $\lambda = -1, -1$ , and from eq.(254) this corresponds to a periodic solution with period  $2T$ . This gives the important result that *on the transition curves in parameter space between stable and unstable, there exist periodic motions of*

period  $T$  or  $2T$ .

The theory presented in this section can be used as a practical numerical procedure for determining stability of a Hill's equation. Begin by numerically integrating the o.d.e. for the two initial conditions (257). Carry each numerical integration out to time  $t = T$  and so obtain  $\text{tr}C = x_{11}(T) + x_{22}(T)$ . Then  $|\text{tr}C| > 2$  is unstable, while  $|\text{tr}C| < 2$  is stable. Note that this approach allows you to draw conclusions about large time behavior after numerically integrating for only one forcing period. Without Floquet theory you would have to numerically integrate out to large time in order to determine if a solution was growing unbounded, especially for systems which are close to a transition curve, in which case the asymptotic growth is very slow.

The reader is referred to "Nonlinear Vibrations in Mechanical and Electrical Systems" by J.Stoker, Wiley, 1950, Chapter 6, for a brief treatment of Floquet theory and Hill's equation. See "Hill's Equation" by W.Magnus and S.Winkler, Dover, 1979 for a complete treatment.

### 6.4 Harmonic Balance

In this section we apply Floquet theory to Mathieu's equation (227). Since the period of the forcing function in (227) is  $T = 2\pi$ , we may apply the result obtained in the previous section to conclude that on the transition curves in the  $\delta$ - $\epsilon$  parameter plane there exist solutions of period  $2\pi$  or  $4\pi$ . This motivates us to look for such a solution in the form of a Fourier series:

$$x(t) = \sum_{n=0}^{\infty} a_n \cos \frac{nt}{2} + b_n \sin \frac{nt}{2} \tag{263}$$

This series represents a general periodic function with period  $4\pi$ , and includes functions with period  $2\pi$  as a special case (when  $a_{odd}$  and  $b_{odd}$  are zero). Substituting (263) into Mathieu's equation (227), simplifying the trig and collecting terms (a procedure called *harmonic balance*) gives four sets of algebraic equations on the coefficients  $a_n$  and  $b_n$ . Each set deals exclusively with  $a_{even}$ ,  $b_{even}$ ,  $a_{odd}$  and  $b_{odd}$ , respectively. Each set is homogeneous and of infinite order, so for a nontrivial solution the determinants must vanish. This gives four infinite determinants (called Hill's determinants):

$$a_{even} : \begin{vmatrix} \delta & \epsilon/2 & 0 & 0 & \dots \\ \epsilon & \delta - 1 & \epsilon/2 & 0 & \dots \\ 0 & \epsilon/2 & \delta - 4 & \epsilon/2 & \dots \\ & & & \dots & \dots \end{vmatrix} = 0 \tag{264}$$

$$b_{even} : \begin{vmatrix} \delta - 1 & \epsilon/2 & 0 & 0 & \dots \\ \epsilon/2 & \delta - 4 & \epsilon/2 & 0 & \dots \\ 0 & \epsilon/2 & \delta - 9 & \epsilon/2 & \dots \\ & & & \dots & \dots \end{vmatrix} = 0 \tag{265}$$

$$a_{odd} : \begin{vmatrix} \delta - 1/4 + \epsilon/2 & \epsilon/2 & 0 & 0 & \dots \\ \epsilon/2 & \delta - 9/4 & \epsilon/2 & 0 & \dots \\ 0 & \epsilon/2 & \delta - 25/4 & \epsilon/2 & \dots \\ & & & \dots & \dots \end{vmatrix} = 0 \tag{266}$$

$$b_{odd} : \left| \begin{array}{cccc} \delta - 1/4 - \epsilon/2 & \epsilon/2 & 0 & 0 \\ \epsilon/2 & \delta - 9/4 & \epsilon/2 & 0 \\ 0 & \epsilon/2 & \delta - 25/4 & \epsilon/2 \\ & & \dots & \dots \end{array} \right| = 0 \quad (267)$$

In all four determinants the typical row is of the form:

$$\dots \quad 0 \quad \epsilon/2 \quad \delta - n^2/4 \quad \epsilon/2 \quad 0 \quad \dots$$

(except for the first one or two rows).

Each of these four determinants represents a functional relationship between  $\delta$  and  $\epsilon$ , which plots as a set of transition curves in the  $\delta$ - $\epsilon$  plane. By setting  $\epsilon = 0$  in these determinants it is easy to see where the associated curves intersect the  $\delta$  axis. The transition curves obtained from the  $a_{even}$  and  $b_{even}$  determinants intersect the  $\delta$  axis at  $\delta = n^2$ ,  $n = 0, 1, 2, \dots$ , while those obtained from the  $a_{odd}$  and  $b_{odd}$  determinants intersect the  $\delta$  axis at  $\delta = \frac{(2n+1)^2}{4}$ ,  $n = 0, 1, 2, \dots$ . For  $\epsilon > 0$ , each of these points on the  $\delta$  axis gives rise to two transition curves, one coming from the associated  $a$  determinant, and the other from the  $b$  determinant. Thus there is a tongue of instability emanating from each of the following points on the  $\delta$  axis:

$$\delta = \frac{n^2}{4}, \quad n = 0, 1, 2, 3, \dots \quad (268)$$

The  $n = 0$  case is an exception as only one transition curve emanates from it, as a comparison of eq.(264) with eq.(265) will show.

Note that the transition curves (245) found earlier in this Chapter by using the two variable expansion method correspond to  $n = 1$  in eq.(268). Why did the perturbation method miss the other tongues of instability? It was because we truncated the perturbation method, neglecting terms of  $O(\epsilon^2)$ . The other tongues of instability turn out to emerge at higher order truncations in the various perturbation methods (two variable expansion, averaging, Lie transforms, normal forms, even regular perturbations). In all cases these methods deliver an expression for a particular transition curve in the form of a power series expansion:

$$\delta = \frac{n^2}{4} + \delta_1 \epsilon + \delta_2 \epsilon^2 + \dots \quad (269)$$

As an alternative method of obtaining such an expansion, we can simply substitute (269) into any of the determinants (264)-(267) and collect terms, in order to obtain values for the coefficients  $\delta_i$ . As an example, let us substitute (269) for  $n = 1$  into the  $a_{odd}$  determinant (266). Expanding a  $3 \times 3$  truncation of (266), we get (using computer algebra):

$$-\frac{\epsilon^3}{8} - \frac{\delta \epsilon^2}{2} + \frac{13 \epsilon^2}{8} + \frac{\delta^2 \epsilon}{2} - \frac{17 \delta \epsilon}{4} + \frac{225 \epsilon}{32} + \delta^3 - \frac{35 \delta^2}{4} + \frac{259 \delta}{16} - \frac{225}{64} \quad (270)$$

Substituting (269) with  $n = 1$  into (270) and collecting terms gives:

$$(12 \delta_1 + 6) \epsilon + \frac{(24 \delta_2 - 16 \delta_1^2 - 8 \delta_1 + 3) \epsilon^2}{2} + \dots \quad (271)$$

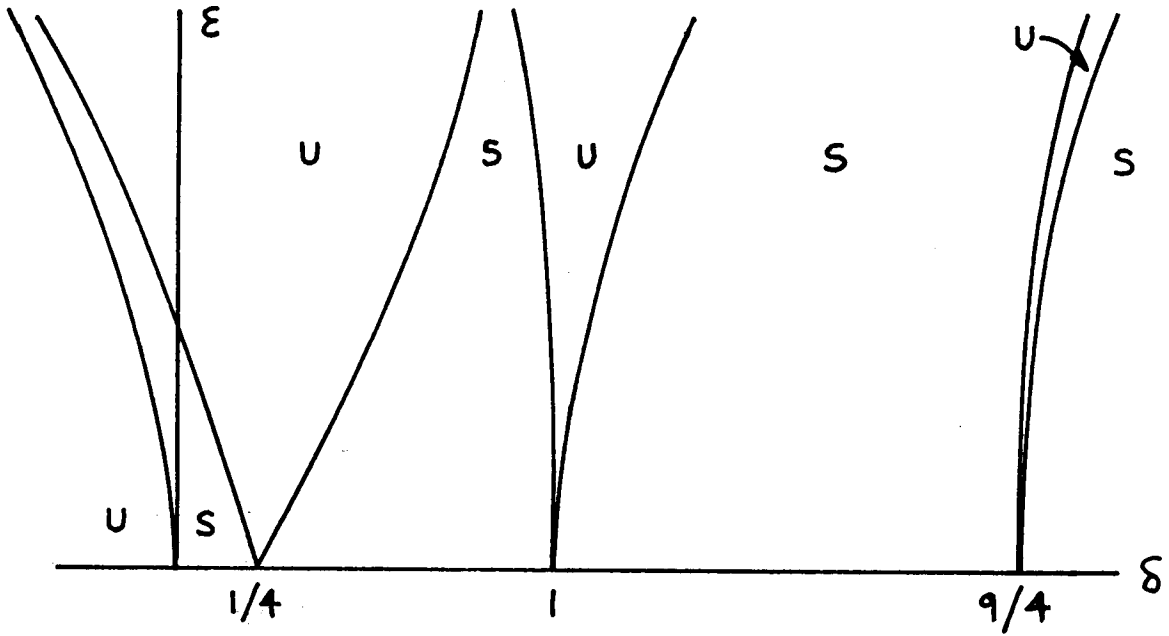

Transition curves in Mathieu's equation. S=stable, U=unstable.

Requiring the coefficients of  $\epsilon$  and  $\epsilon^2$  in (271) to vanish gives:

$$\delta_1 = -\frac{1}{2}, \quad \delta_2 = -\frac{1}{8} \tag{272}$$

This process can be continued to any order of truncation. Here are the expansions of the first few transition curves:

$$\delta = -\frac{\epsilon^2}{2} + \frac{7\epsilon^4}{32} - \frac{29\epsilon^6}{144} + \frac{68687\epsilon^8}{294912} - \frac{123707\epsilon^{10}}{409600} + \frac{8022167579\epsilon^{12}}{19110297600} + \dots \tag{273}$$

$$\begin{aligned} \delta = & \frac{1}{4} - \frac{\epsilon}{2} - \frac{\epsilon^2}{8} + \frac{\epsilon^3}{32} - \frac{\epsilon^4}{384} - \frac{11\epsilon^5}{4608} + \frac{49\epsilon^6}{36864} - \frac{55\epsilon^7}{294912} - \frac{83\epsilon^8}{552960} \\ & + \frac{12121\epsilon^9}{117964800} - \frac{114299\epsilon^{10}}{6370099200} - \frac{192151\epsilon^{11}}{15288238080} + \frac{83513957\epsilon^{12}}{8561413324800} + \dots \end{aligned} \tag{274}$$

$$\begin{aligned} \delta = & \frac{1}{4} + \frac{\epsilon}{2} - \frac{\epsilon^2}{8} - \frac{\epsilon^3}{32} - \frac{\epsilon^4}{384} + \frac{11\epsilon^5}{4608} + \frac{49\epsilon^6}{36864} + \frac{55\epsilon^7}{294912} - \frac{83\epsilon^8}{552960} \\ & - \frac{12121\epsilon^9}{117964800} - \frac{114299\epsilon^{10}}{6370099200} + \frac{192151\epsilon^{11}}{15288238080} + \frac{83513957\epsilon^{12}}{8561413324800} + \dots \end{aligned} \tag{275}$$

$$\begin{aligned} \delta = & 1 - \frac{\epsilon^2}{12} + \frac{5\epsilon^4}{3456} - \frac{289\epsilon^6}{4976640} + \frac{21391\epsilon^8}{7166361600} \\ & - \frac{2499767\epsilon^{10}}{14447384985600} + \frac{1046070973\epsilon^{12}}{97086427103232000} + \dots \end{aligned} \tag{276}$$

$$\begin{aligned} \delta = & 1 + \frac{5\epsilon^2}{12} - \frac{763\epsilon^4}{3456} + \frac{1002401\epsilon^6}{4976640} - \frac{1669068401\epsilon^8}{7166361600} \\ & + \frac{4363384401463\epsilon^{10}}{14447384985600} - \frac{40755179450909507\epsilon^{12}}{97086427103232000} + \dots \end{aligned} \tag{277}$$

### 6.5 Effect of Damping

In this section we investigate the effect that damping has on the transition curves of Mathieu's equation by applying the two variable expansion method to the following equation, known as the damped Mathieu equation:

$$\frac{d^2x}{dt^2} + c\frac{dx}{dt} + (\delta + \epsilon \cos t) x = 0 \tag{278}$$

In order to facilitate the perturbation method, we scale the damping coefficient  $c$  to be  $O(\epsilon)$ :

$$c = \epsilon\mu \tag{279}$$

We can use the same setup that we did earlier in this Chapter, whereupon eq.(232) becomes:

$$\frac{\partial^2 x}{\partial \xi^2} + 2\epsilon \frac{\partial^2 x}{\partial \xi \partial \eta} + \epsilon^2 \frac{\partial^2 x}{\partial \eta^2} + \epsilon \mu \left( \frac{\partial x}{\partial \xi} + \epsilon \frac{\partial x}{\partial \eta} \right) + (\delta + \epsilon \cos \xi) x = 0 \quad (280)$$

Now we expand  $x$  as in eq.(233) and  $\delta$  as in eq.(242), and we find that eq.(243) gets an additional term:

$$\frac{\partial^2 x_1}{\partial \xi^2} + \frac{1}{4} x_1 = -2 \frac{\partial^2 x_0}{\partial \xi \partial \eta} - x_0 \cos \xi - \delta_1 x_0 - \mu \frac{\partial x_0}{\partial \xi} \quad (281)$$

which results in two additional terms appearing in the slow flow eqs.(244):

$$\frac{dA}{d\eta} = -\frac{\mu}{2}A + \left( \delta_1 - \frac{1}{2} \right) B, \quad \frac{dB}{d\eta} = -\left( \delta_1 + \frac{1}{2} \right) A - \frac{\mu}{2}B \quad (282)$$

Eqs.(282) are a linear constant coefficient system which may be solved by assuming a solution in the form  $A(\eta) = A_0 \exp(\lambda\eta)$ ,  $B(\eta) = B_0 \exp(\lambda\eta)$ . For nontrivial constants  $A_0$  and  $B_0$ , the following determinant must vanish:

$$\begin{vmatrix} -\frac{\mu}{2} - \lambda & -\frac{1}{2} + \delta_1 \\ -\frac{1}{2} - \delta_1 & -\frac{\mu}{2} - \lambda \end{vmatrix} = 0 \quad \Rightarrow \quad \lambda = -\frac{\mu}{2} \pm \sqrt{-\delta_1^2 + \frac{1}{4}} \quad (283)$$

For the transition between stable and unstable, we set  $\lambda = 0$ , giving the following value for  $\delta_1$ :

$$\delta_1 = \pm \frac{\sqrt{1 - \mu^2}}{2} \quad (284)$$

This gives the following expressions for the  $n = 1$  transition curves:

$$\delta = \frac{1}{4} \pm \epsilon \frac{\sqrt{1 - \mu^2}}{2} + O(\epsilon^2) = \frac{1}{4} \pm \frac{\sqrt{\epsilon^2 - c^2}}{2} + O(\epsilon^2) \quad (285)$$

Eq.(285) predicts that for a given value of  $c$  there is a minimum value of  $\epsilon$  which is required for instability to occur. The  $n = 1$  tongue, which for  $c = 0$  emanates from the  $\delta$  axis, becomes detached from the  $\delta$  axis for  $c > 0$ . This prediction is verified by numerically integrating eq.(278) for fixed  $c$ , while  $\delta$  and  $\epsilon$  are permitted to vary.

## 6.6 Effect of Nonlinearity

In the previous sections of this Chapter we have seen how unbounded solutions to Mathieu's equation (227) can result from resonances between the forcing frequency and the oscillator's unforced natural frequency. However, real physical systems do not exhibit unbounded behavior. The difference lies in the fact that the Mathieu equation is linear. The effects of nonlinearity can be explained as follows: as the resonance causes the amplitude of the motion to increase, the relation between period and amplitude (which is a characteristic effect of nonlinearity) causes the resonance to detune, decreasing its tendency to produce large motions.



# DAMPED MATHIEU EQUATION

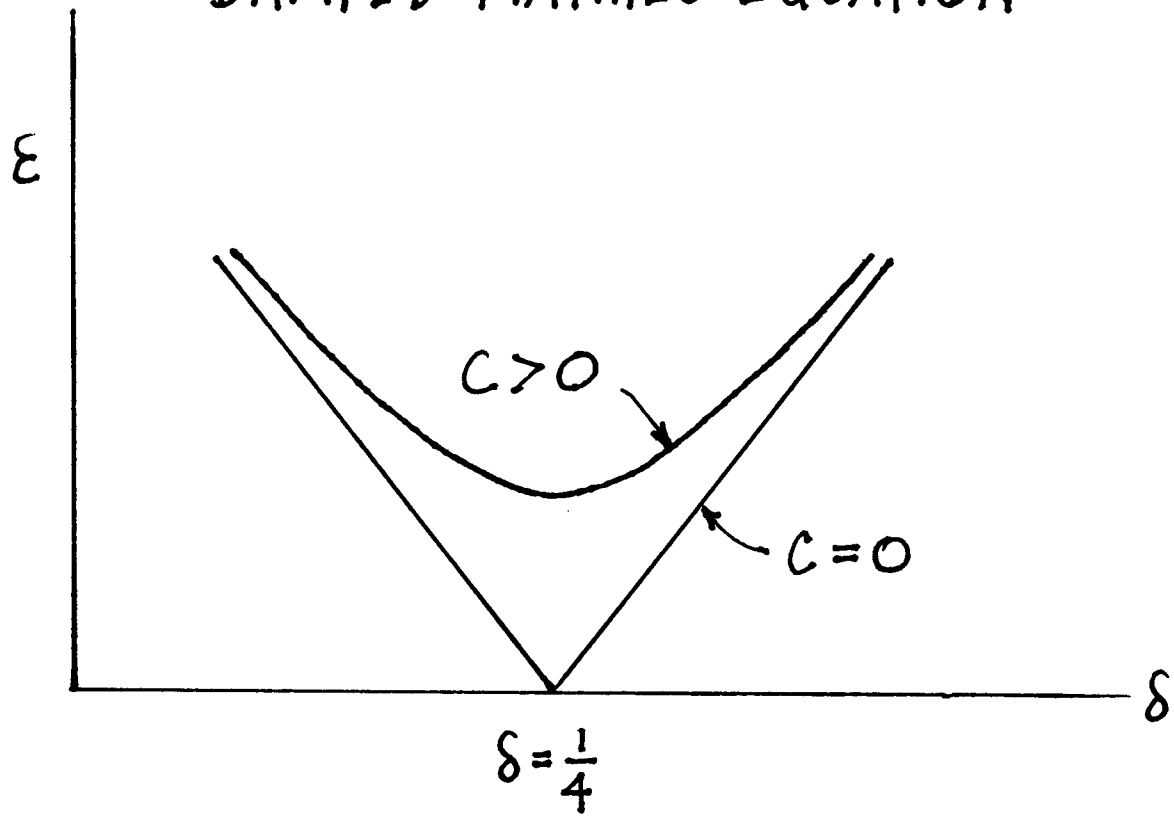

A more realistic model can be obtained by including nonlinear terms in the Mathieu equation. For example, in the case of the vertically driven pendulum, eq.(228), if we expand  $\sin x$  in a Taylor series, we get:

$$\frac{d^2x}{dt^2} + \left(\frac{g}{L} - \frac{A\omega^2}{L} \cos \omega t\right) \left(x - \frac{x^3}{6} + \dots\right) = 0 \tag{286}$$

Now if we rescale time by  $\tau = \omega t$  and set  $\delta = \frac{g}{\omega^2 L}$  and  $\epsilon = \frac{A}{L}$ , we get:

$$\frac{d^2x}{d\tau^2} + (\delta - \epsilon \cos \tau) \left(x - \frac{x^3}{6} + \dots\right) = 0 \tag{287}$$

Next, if we scale  $x$  by  $x = \sqrt{\epsilon} y$  and neglect terms of  $O(\epsilon^2)$ , we get:

$$\frac{d^2y}{d\tau^2} + (\delta - \epsilon \cos \tau) y - \frac{\delta}{6} y^3 + O(\epsilon^2) = 0 \tag{288}$$

Motivated by this example, in this section we study the following nonlinear Mathieu equation:

$$\frac{d^2x}{dt^2} + (\delta + \epsilon \cos t) x + \epsilon \alpha x^3 = 0 \tag{289}$$

We once again use the two variable expansion method to treat this equation. Using the same setup that we did earlier in this Chapter, eq.(232) becomes:

$$\frac{\partial^2 x}{\partial \xi^2} + 2\epsilon \frac{\partial^2 x}{\partial \xi \partial \eta} + \epsilon^2 \frac{\partial^2 x}{\partial \eta^2} + (\delta + \epsilon \cos \xi) x + \epsilon \alpha x^3 = 0 \tag{290}$$

We expand  $x$  as in eq.(233) and  $\delta$  as in eq.(242), and we find that eq.(243) gets an additional term:

$$\frac{\partial^2 x_1}{\partial \xi^2} + \frac{1}{4} x_1 = -2 \frac{\partial^2 x_0}{\partial \xi \partial \eta} - x_0 \cos \xi - \delta_1 x_0 - \alpha x_0^3 \tag{291}$$

where  $x_0$  is of the form:

$$x_0(\xi, \eta) = A(\eta) \cos \frac{\xi}{2} + B(\eta) \sin \frac{\xi}{2} \tag{292}$$

Removal of resonant terms in (291) results in the appearance of some additional cubic terms in the slow flow eqs.(244):

$$\frac{dA}{d\eta} = \left(\delta_1 - \frac{1}{2}\right) B + \frac{3\alpha}{4} B(A^2 + B^2), \quad \frac{dB}{d\eta} = -\left(\delta_1 + \frac{1}{2}\right) A - \frac{3\alpha}{4} A(A^2 + B^2) \tag{293}$$

In order to more easily work with the slow flow (293), we transform to polar coordinates in the  $A$ - $B$  phase plane:

$$A = R \cos \theta, \quad B = R \sin \theta \tag{294}$$

Note that eqs.(294) and (292) give the following alternate expression for  $x_0$ :

$$x_0(\xi, \eta) = R(\eta) \cos \left(\frac{\xi}{2} - \theta(\eta)\right) \tag{295}$$

# Nonlinear Mathieu Equation ( $\alpha > 0$ )

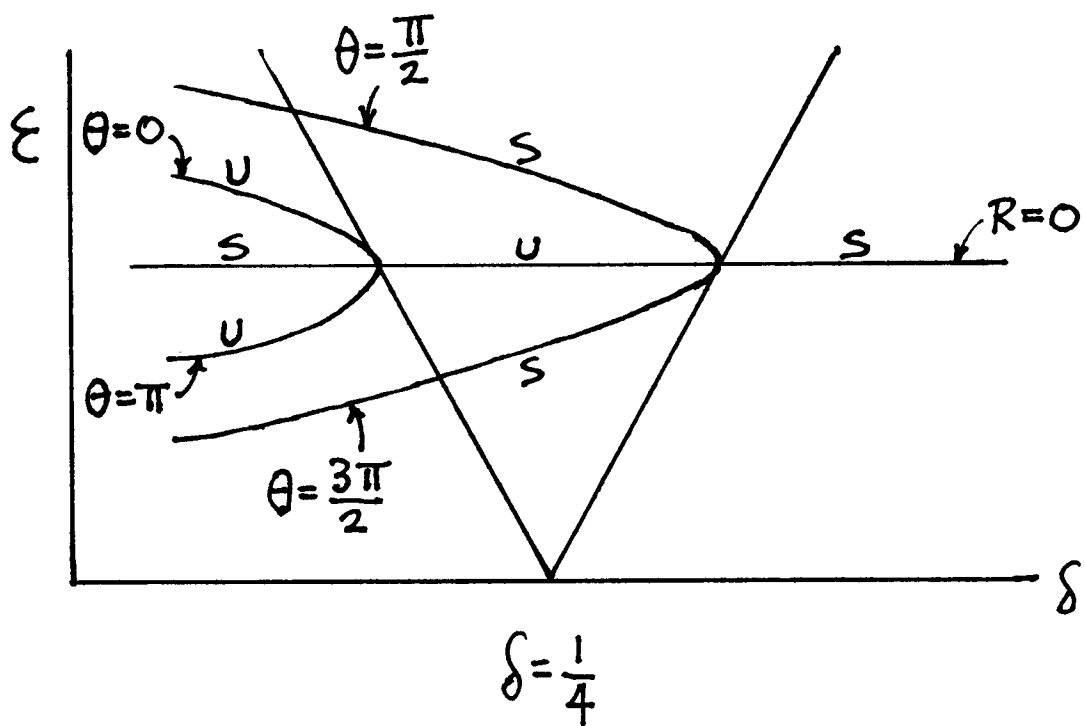
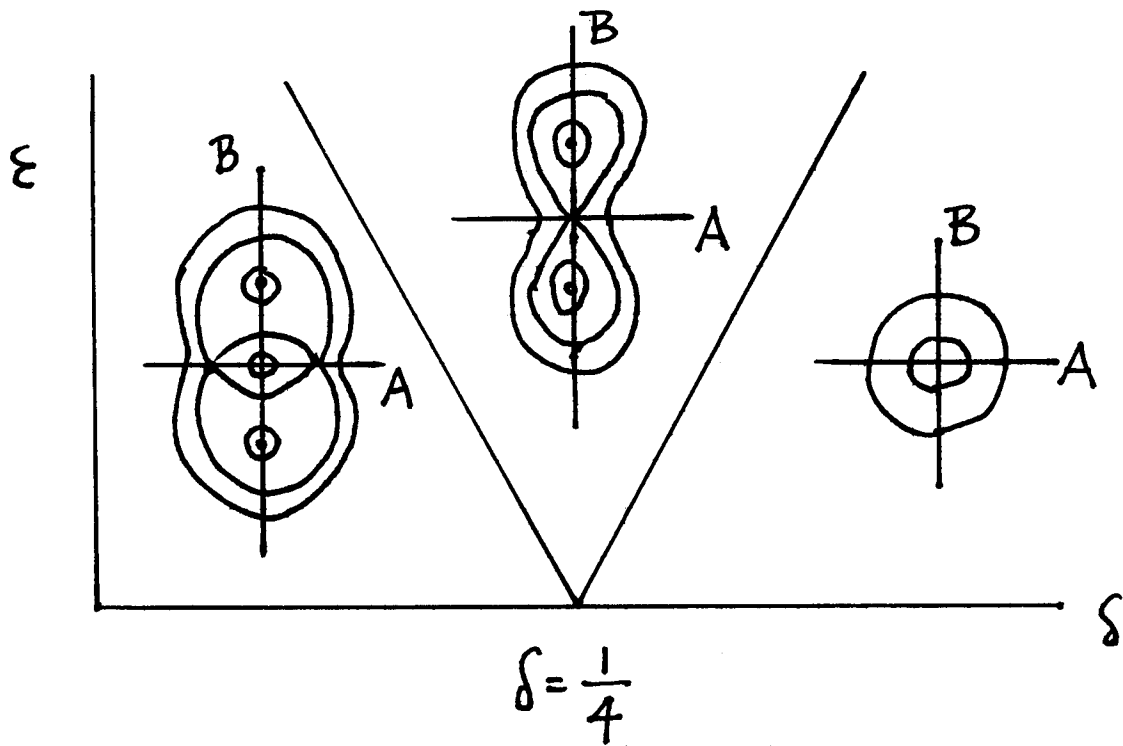

Substitution of (294) into the slow flow (293) gives:

$$\frac{dR}{d\eta} = -\frac{R}{2} \sin 2\theta, \quad \frac{d\theta}{d\eta} = -\delta_1 - \frac{\cos 2\theta}{2} - \frac{3\alpha}{4}R^2 \tag{296}$$

We seek equilibria of the slow flow (296). From (295), a solution in which  $R$  and  $\theta$  are constant in slow time  $\eta$  represents a periodic motion of the nonlinear Mathieu equation (289) which has one-half the frequency of the forcing function, that is, such a motion is a 2:1 subharmonic. Such slow flow equilibria satisfy the equations:

$$-\frac{R}{2} \sin 2\theta = 0, \quad -\delta_1 - \frac{\cos 2\theta}{2} - \frac{3\alpha}{4}R^2 = 0 \tag{297}$$

Ignoring the trivial solution  $R = 0$ , the first eq. of (297) requires  $\sin 2\theta = 0$  or  $\theta = 0, \frac{\pi}{2}, \pi$  or  $\frac{3\pi}{2}$ . Solving the second eq. of (297) for  $R^2$ , we get:

$$R^2 = -\frac{4}{3\alpha} \left( \frac{\cos 2\theta}{2} + \delta_1 \right) \tag{298}$$

For a nontrivial real solution,  $R^2 > 0$ . Let us assume that the nonlinearity parameter  $\alpha > 0$ . Then in the case of  $\theta = 0$  or  $\pi$ ,  $\cos 2\theta = 1$  and nontrivial equilibria exist only for  $\delta_1 < -\frac{1}{2}$ . On the other hand, for  $\theta = \frac{\pi}{2}$  or  $\frac{3\pi}{2}$ ,  $\cos 2\theta = -1$  and nontrivial equilibria require  $\delta_1 < \frac{1}{2}$ .

Since  $\delta_1 = \pm\frac{1}{2}$  corresponds to transition curves for the stability of the trivial solution, the analysis predicts that bifurcations occur as we cross the transition curves in the  $\delta$ - $\epsilon$  plane. That is, imagine quasistatically decreasing the parameter  $\delta$  while  $\epsilon$  is kept fixed, and moving through the  $n = 1$  tongue emanating from the point  $\delta = \frac{1}{4}$  on the  $\delta$  axis. As  $\delta$  decreases across the right transition curve, the trivial solution  $x = 0$  becomes unstable and simultaneously a stable 2:1 subharmonic motion is born. This motion grows in amplitude as  $\delta$  continues to decrease. When the left transition curve is crossed, the trivial solution becomes stable again, and an unstable 2:1 subharmonic is born. This scenario can be pictured as involving two pitchfork bifurcations.

If the nonlinearity parameter  $\alpha < 0$ , a similar sequence of bifurcations occurs, except in this case the subharmonic motions are born as  $\delta$  *increases* quasistatically through the  $n = 1$  tongue.

## 6.7 Problems

### Problem 6.1

Alternatives to Floquet theory. As we saw in this Chapter, Floquet theory offers an approach to determining the stability (that is the boundedness of all solutions) of the  $n$ -dimensional linear system with periodic coefficients:

$$\frac{dx}{dt} = A(t) x, \quad A(t + T) = A(t) \tag{299}$$

where  $x$  is an  $n$ -vector and  $A(t)$  is an  $n \times n$  matrix.

This problem involves three alternative approaches. For each one, decide whether or not it is valid. If you think a method is valid, offer a line of reasoning showing why it works. If you think it is wrong, explain why it doesn't work or find a counterexample.

1. Set  $x = Ty$  where  $y$  is an  $n$ -vector and  $T$  is an  $n \times n$  matrix. Then  $\frac{dy}{dt} = T^{-1}ATy$ . Choose  $T$  such that  $T^{-1}AT = D$  is diagonal (or more generally in Jordan canonical form). Then study the uncoupled system  $\frac{dy}{dt} = Dy$ .

2. Consider  $\frac{dx}{dt} = A(t^*)x$  for  $t^*$  a fixed value of  $t$ . Examine the eigenvalues of  $A(t^*)$ . If the real parts of these eigenvalues remain negative for all positive  $t^*$ , then the solutions are asymptotically stable.

3. Replace the given equations by the averaged equations,  $\frac{dx}{dt} = Bx$ , where  $B = \frac{1}{T} \int_0^T A(t)dt$ . Note that  $B$  is a constant coefficient matrix. Use the usual stability criteria on  $\frac{dx}{dt} = Bx$ .

### Problem 6.2

Nonlinear parametric resonance. This problem concerns the following differential equation:

$$\frac{d^2x}{dt^2} + \left(\frac{1}{4} + \epsilon k_1\right)x + \epsilon x^3 \cos t = 0, \quad \epsilon \ll 1 \quad (300)$$

a) Use the two variable expansion method to derive a slow flow, neglecting terms of  $O(\epsilon^2)$ .

b) Analyze the slow flow. In particular, determine all slow flow equilibria and their stability. Make a sketch of the slow flow phase portrait for  $k_1 = 0$  and for  $k_1 = 0.1$ .

### Problem 6.3

The particle in the plane. Earlier in this Chapter we showed that the stability of the  $x$ -mode of the particle in the plane is governed by eq.(230) which may be written in the form:

$$\frac{d^2v}{dt^2} + \left(\frac{\delta - \epsilon \cos^2 t}{1 - \epsilon \cos^2 t}\right)v = 0 \quad (301)$$

where  $\delta = 1 - L$  and  $\epsilon = A^2$ . Using the method of harmonic balance, obtain an approximate expression for the transition curve in the  $\delta$ - $\epsilon$  plane which passes through the origin ( $\delta = 0$ ,  $\epsilon = 0$ ). Neglect terms of  $O(\epsilon^4)$ .

**Problem 6.4**

Nonlinear Mathieu equation. This question concerns eq.(289) for  $\alpha > 0$ :

$$\frac{d^2x}{dt^2} + (\delta + \epsilon \cos t)x + \epsilon\alpha x^3 = 0, \quad \alpha > 0 \quad (302)$$

We saw in section 6.6 that the periodic motions in this equation decrease in frequency as the amplitude increases. See the Figure in section 6.6, where the pitchforks bend to the left. The explanation given for these motions was that “as the resonance causes the amplitude of the motion to increase, the relation between period and amplitude (which is a characteristic effect of nonlinearity) causes the resonance to detune, decreasing its tendency to produce large motions.” However, periodic motions in the unforced equation (which is an undamped Duffing equation) have been shown in section 4.1 to increase in frequency as the amplitude increases. See Figure in section 4.1, where the  $F = 0$  *backbone* curve bends to the right. Explain.

**Problem 6.5**

Damped Mathieu equation and Floquet theory. This question concerns eq.(278) for  $\delta=1/4$ , exact 2:1 resonance (no detuning):

$$\frac{d^2x}{dt^2} + c\frac{dx}{dt} + \left(\frac{1}{4} + \epsilon \cos t\right)x = 0 \quad (303)$$

- Find an approximate expression for the transition curve separating stable regions from unstable regions in the  $c$ - $\epsilon$  parameter plane, valid for small  $\epsilon$ .
- Compare your answer with results obtained by numerically integrating eq.(303) in conjunction with Floquet theory.

Hint: For a given pair of parameters  $(c, \epsilon)$ , numerically integrate (303) twice, respectively for initial conditions  $x=1, dx/dt=0$  and  $x=0, dx/dt = 1$ . Evaluate the two resulting solution vectors at time  $t = 2\pi$ , and use them as the columns in the fundamental solution matrix  $X(T)$  referred to in eq.(248). Compute the eigenvalues  $\lambda_1, \lambda_2$  of this matrix. As discussed in the text, stability requires that both eigenvalues satisfy  $|\lambda_i| < 1$ .

## 7 Ince's Equation

The equation

$$(1 + a \cos 2t) \frac{d^2x}{dt^2} + b \sin 2t \frac{dx}{dt} + (c + d \cos 2t) x = 0 \quad (304)$$

which is called Ince's equation, occurs in a variety of mechanics problems. It includes Mathieu's equation as a special case (for which  $a = b = 0$ ). However because Ince's equation contains 4 parameters instead of only 2 for Mathieu's equation, a certain phenomenon called *coexistence* can occur in Ince's equation, but not in Mathieu's equation. The phenomenon of coexistence involves the disappearance of tongues of instability which would ordinarily be there.

As an example, consider the equation

$$\left(1 + \frac{\epsilon}{2} \cos 2t\right) \frac{d^2x}{dt^2} + \frac{\epsilon}{2} \sin 2t \frac{dx}{dt} + c x = 0 \quad (305)$$

which is Ince's equation with  $a = b = \epsilon/2$  and  $d = 0$ . We are interested in the location of the transition curves of (305) in the  $c - \epsilon$  plane, which separate regions of stability (all solutions bounded) from regions of instability (an unbounded solution exists). A straightforward line of reasoning leads us to expect tongues of instability to emanate from the points  $c = n^2$ ,  $n = 1, 2, 3, \dots$  on the  $c$ -axis. Let us examine this reasoning. We have seen that Floquet theory tells us that equations of the form of Hill's equation,

$$\frac{d^2z}{dt^2} + f(t) z = 0, \quad f(t + T) = f(t) \quad (306)$$

have periodic solutions of period  $T$  or  $2T$  on their transition curves. However, eq.(305) is not of the form of Hill's equation (306). Nevertheless, if we set

$$x = \left(1 + \frac{\epsilon}{2} \cos 2t\right)^{\frac{1}{4}} z \quad (307)$$

then it turns out that eq.(305) becomes a Hill's equation (306) on  $z(t)$ , with the following coefficient  $f(t)$ :

$$f(t) = \frac{\epsilon^2 \cos 4t + 16\epsilon(c - 1) \cos 2t + 32c - 9\epsilon^2}{4(\epsilon^2 \cos 4t + 8\epsilon \cos 2t + 8 + \epsilon^2)} \quad (308)$$

Here  $f(t)$  is periodic with period  $\pi$ . Thus Floquet theory tells us that the resulting Hill's equation on  $z(t)$  will have solutions of period  $\pi$  or  $2\pi$  on its transition curves. Now from eq.(307), the boundedness of  $z(t)$  is equivalent to the boundedness of  $x(t)$ , so transition curves for the  $z$  equation occur for the same parameters as do those for the  $x$  equation (305). Also, since the coefficient  $\left(1 + \frac{\epsilon}{2} \cos 2t\right)^{\frac{1}{4}}$  in eq.(307) has period  $\pi$ , we may conclude that eq.(305) has solutions of period  $\pi$  or  $2\pi$  on its transition curves. Now when  $\epsilon = 0$ , eq.(305) is of the form  $\frac{d^2x}{dt^2} + c x = 0$ , and has solutions of period  $\frac{2\pi}{\sqrt{c}}$ . These will correspond to solutions of period  $\pi$  or  $2\pi$  when  $\frac{2\pi}{\sqrt{c}} = \frac{2\pi}{n}$ , since a solution with period  $\frac{2\pi}{n}$  may also be thought of as having period  $\pi$  ( $n$  even) or  $2\pi$  ( $n$  odd), which gives  $c = n^2$ ,  $n = 1, 2, 3, \dots$  as claimed above.

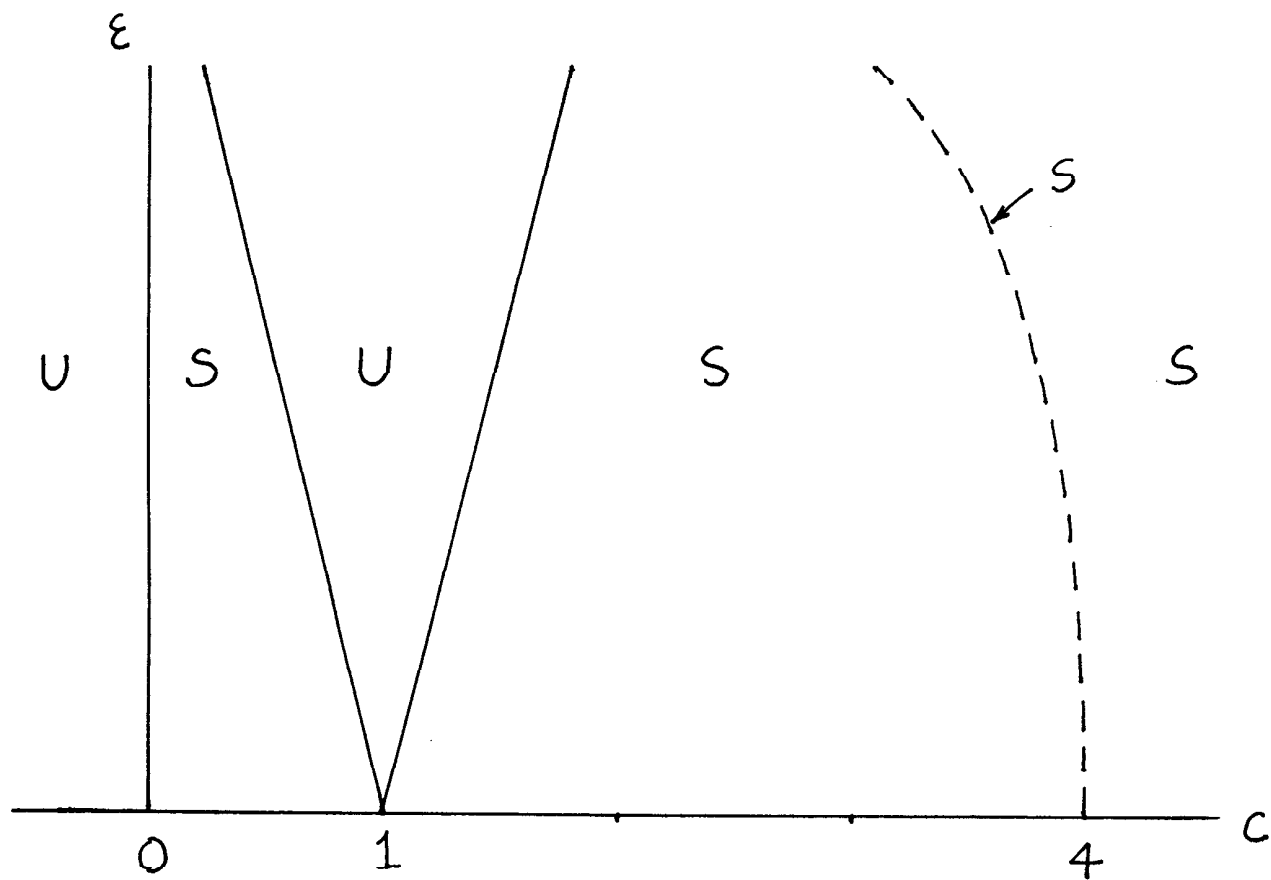

Stability chart for  $(1 + \frac{\epsilon}{2} \cos 2t) \frac{d^2x}{dt^2} + \frac{\epsilon}{2} \sin 2t \frac{dx}{dt} + c x = 0$ . S=Stable, U=Unstable. Note that there is only a single tongue of instability. The usual instability regions which emanate from the points  $c = n^2$ ,  $n = 2, 3, \dots$  on the  $c$ -axis have zero width (and hence do not exist) due to *coexistence*.



To reiterate, the purpose of the preceding long-winded paragraph was to show that we can expect eq.(305) to have tongues of instability emanating from the points  $c = n^2$ ,  $n = 1, 2, 3, \dots$  on the  $c$ -axis. While this would be true in general for an equation of the type (304), the coefficients in eq.(305) have been especially chosen to illustrate the phenomenon of coexistence. In fact, eq.(305) has only one tongue of instability which emanates from the point  $c = 1$  on the  $c$ -axis! See Figure.

### 7.1 Coexistence

In order to understand what happened to all the tongues of instability which we expected to occur in eq.(305), we use the method of harmonic balance. Since the transition curves are characterized by the occurrence of a periodic solution of period  $\pi$  or  $2\pi$ , we expand the solution  $x$  in a Fourier series:

$$x(t) = \sum_{n=0}^{\infty} a_n \cos nt + b_n \sin nt \tag{309}$$

This series represents a general periodic function of period  $2\pi$ , and includes functions of period  $\pi$  as a special case (when  $a_{odd}$  and  $b_{odd}$  are zero). Substituting (309) into eq.(305), simplifying the trig and collecting terms, we obtain four sets of algebraic equations on the coefficients  $a_n$  and  $b_n$ . Each set deals exclusively with  $a_{even}$ ,  $b_{even}$ ,  $a_{odd}$  and  $b_{odd}$ , respectively. Each set is homogeneous and of infinite order, so for a nontrivial solution the determinants must vanish. This gives four infinite determinants:

$$a_{even} : \begin{vmatrix} c & -\frac{3\epsilon}{2} & 0 & 0 & 0 & \dots \\ 0 & c-4 & -5\epsilon & 0 & 0 & \dots \\ 0 & -\frac{\epsilon}{2} & c-16 & -\frac{21\epsilon}{2} & 0 & \dots \\ 0 & 0 & -3\epsilon & c-36 & -18\epsilon & \dots \\ & & & \dots & & \dots \end{vmatrix} = 0 \tag{310}$$

$$b_{even} : \begin{vmatrix} c-4 & -5\epsilon & 0 & 0 & \dots \\ -\frac{\epsilon}{2} & c-16 & -\frac{21\epsilon}{2} & 0 & \dots \\ 0 & -3\epsilon & c-36 & -18\epsilon & \dots \\ & & \dots & & \dots \end{vmatrix} = 0 \tag{311}$$

$$a_{odd} : \begin{vmatrix} c-1-\frac{\epsilon}{2} & -3\epsilon & 0 & 0 & \dots \\ 0 & c-9 & -\frac{15\epsilon}{2} & 0 & \dots \\ 0 & -\frac{3\epsilon}{2} & c-25 & -14\epsilon & \dots \\ & & \dots & & \dots \end{vmatrix} = 0 \tag{312}$$

$$b_{odd} : \begin{vmatrix} c-1+\frac{\epsilon}{2} & -3\epsilon & 0 & 0 & \dots \\ 0 & c-9 & -\frac{15\epsilon}{2} & 0 & \dots \\ 0 & -\frac{3\epsilon}{2} & c-25 & -14\epsilon & \dots \\ & & \dots & & \dots \end{vmatrix} = 0 \tag{313}$$

If we represent by  $\Delta_0$  the determinant (311) of the  $b_{even}$  coefficients, then the determinant (310) of the  $a_{even}$  coefficients may be written  $c\Delta_0$ , a result obtainable by doing a Laplace expansion down the first column. This gives us that  $c = 0$  is the exact equation of a transition curve. Examination of (310) shows that on  $c = 0$  we have the exact solution  $x(t) = a_0$ , the other  $a_{even}$

coefficients vanishing on  $c = 0$ . Note that  $x(t) = a_0 (= 1 \text{ say})$  may be considered a  $\pi$ -periodic solution.

On the other hand, we may also satisfy eq.(310) by taking  $\Delta_0 = 0$ , which corresponds to taking  $a_0 = 0$  while the other  $a_{even}$  coefficients do not in general vanish. Note that this same condition  $\Delta_0 = 0$  gives a nontrivial solution for the  $b_{even}$  coefficients. Thus on the transition curves corresponding to  $\Delta_0 = 0$  we have the *coexistence* of two linearly independent  $\pi$ -periodic solutions, one even and the other odd. Now a region of instability usually lies between two such transition curves, one of which has an even  $\pi$ -periodic solution on it, and the other of which has an odd  $\pi$ -periodic solution. In the case where two such periodic functions coexist, the instability region disappears (or rather has zero width). In the case of eq.(305), all of the even coefficient ( $\pi$ -periodic) tongues disappear.

Let us turn now to eqs.(312),(313) on the coefficients  $a_{odd}$  and  $b_{odd}$ , respectively. The determinant (312) may be written  $(c - 1 - \epsilon/2)\Delta_1$  and the determinant (313) may be written  $(c - 1 + \epsilon/2)\Delta_1$ , where  $\Delta_1$  is the infinite determinant:

$$\Delta_1 = \begin{vmatrix} c - 9 & -\frac{15\epsilon}{2} & 0 & & \\ -\frac{3\epsilon}{2} & c - 25 & -14\epsilon & \dots & \\ & & \dots & & \end{vmatrix} \tag{314}$$

We may satisfy eq.(312) by taking  $c = 1 + \frac{\epsilon}{2}$ . This corresponds to taking  $a_1$  nonzero, and all the other  $a_{odd} = 0$ . Similarly we may satisfy eq.(313) by taking  $c = 1 - \frac{\epsilon}{2}$ , which corresponds to taking  $b_1$  nonzero, and all the other  $b_{odd} = 0$ . Thus we have obtained the following exact expressions for two transition curves emanating from  $c = 1$  on the  $c$ -axis:

$$c = 1 + \frac{\epsilon}{2} \quad \text{on which} \quad x(t) = \cos t \tag{315}$$

$$c = 1 - \frac{\epsilon}{2} \quad \text{on which} \quad x(t) = \sin t \tag{316}$$

All the other transition curves correspond to the vanishing of  $\Delta_1$ . This condition guarantees a nontrivial solution for both the  $a_{odd}$  and the  $b_{odd}$  coefficients, respectively. Since the same relation between  $c$  and  $\epsilon$  produces two linearly independent  $2\pi$ -periodic solutions, we have another instance of coexistence, and the associated tongues of instability do not occur.

### 7.2 Ince's Equation

Let us now apply the foregoing approach to the general version of Ince's equation (304). We substitute the Fourier series (309) into eq.(304), perform the usual trig simplifications and collect terms, thereby obtaining four sets of algebraic equations on the coefficients  $a_n$  and  $b_n$ . For a nontrivial solution, these require that the following four infinite determinants vanish:

$$a_{even} : \begin{vmatrix} c & \frac{d}{2} - b - 2a & 0 & 0 & 0 & & \\ d & c - 4 & \frac{d}{2} - 2b - 8a & 0 & 0 & & \\ 0 & \frac{d}{2} + b - 2a & c - 16 & \frac{d}{2} - 3b - 18a & 0 & \dots & \\ 0 & 0 & \frac{d}{2} + 2b - 8a & c - 36 & \frac{d}{2} - 4b - 32a & & \\ 0 & 0 & 0 & \frac{d}{2} + 3b - 18a & c - 64 & & \\ & & & \dots & & & \end{vmatrix} = 0 \tag{317}$$

$$b_{even} : \begin{vmatrix} c-4 & \frac{d}{2} - 2b - 8a & 0 & 0 \\ \frac{d}{2} + b - 2a & c - 16 & \frac{d}{2} - 3b - 18a & 0 \\ 0 & \frac{d}{2} + 2b - 8a & c - 36 & \frac{d}{2} - 4b - 32a \quad \dots \\ 0 & 0 & \frac{d}{2} + 3b - 18a & c - 64 \\ & & \dots & \end{vmatrix} = 0 \quad (318)$$

$$a_{odd} : \begin{vmatrix} c - 1 + \frac{d-b-a}{2} & \frac{d-3b-9a}{2} & 0 & 0 \\ \frac{d+b-a}{2} & c - 9 & \frac{d-5b-25a}{2} & 0 \\ 0 & \frac{d+3b-9a}{2} & c - 25 & \frac{d-7b-49a}{2} \quad \dots \\ 0 & 0 & \frac{d+5b-25a}{2} & c - 49 \\ & & \dots & \end{vmatrix} = 0 \quad (319)$$

$$b_{odd} : \begin{vmatrix} c - 1 - \frac{d-b-a}{2} & \frac{d-3b-9a}{2} & 0 & 0 \\ \frac{d+b-a}{2} & c - 9 & \frac{d-5b-25a}{2} & 0 \\ 0 & \frac{d+3b-9a}{2} & c - 25 & \frac{d-7b-49a}{2} \quad \dots \\ 0 & 0 & \frac{d+5b-25a}{2} & c - 49 \\ & & \dots & \end{vmatrix} = 0 \quad (320)$$

The notation in these determinants may be simplified by setting (after Magnus and Winkler, “Hill’s Equation”):

$$Q(m) = \frac{d}{2} + bm - 2am^2 \quad (321)$$

$$P(m) = Q\left(m - \frac{1}{2}\right) = \frac{d + 2b\left(m - \frac{1}{2}\right) - 4a\left(m - \frac{1}{2}\right)^2}{2} = \frac{d + b(2m - 1) - a(2m - 1)^2}{2} \quad (322)$$

Using the notation of eqs.(321),(322), the determinants (317)-(320) become:

$$a_{even} : \begin{vmatrix} c & Q(-1) & 0 & 0 & 0 \\ 2Q(0) & c - 4 & Q(-2) & 0 & 0 \\ 0 & Q(1) & c - 16 & Q(-3) & 0 \quad \dots \\ 0 & 0 & Q(2) & c - 36 & Q(-4) \\ 0 & 0 & 0 & Q(3) & c - 64 \\ & & \dots & & \end{vmatrix} = 0 \quad (323)$$

$$b_{even} : \begin{vmatrix} c - 4 & Q(-2) & 0 & 0 \\ Q(1) & c - 16 & Q(-3) & 0 \\ 0 & Q(2) & c - 36 & Q(-4) \quad \dots \\ 0 & 0 & Q(3) & c - 64 \\ & & \dots & \end{vmatrix} = 0 \quad (324)$$

$$a_{odd} : \begin{vmatrix} c - 1 + P(0) & P(-1) & 0 & 0 \\ P(1) & c - 9 & P(-2) & 0 \\ 0 & P(2) & c - 25 & P(-3) \quad \dots \\ 0 & 0 & P(3) & c - 49 \\ & & \dots & \end{vmatrix} = 0 \quad (325)$$

$$b_{odd} : \begin{vmatrix} c-1-P(0) & P(-1) & 0 & 0 & & \\ P(1) & c-9 & P(-2) & 0 & & \\ 0 & P(2) & c-25 & P(-3) & \dots & \\ 0 & 0 & P(3) & c-49 & & \\ & & \dots & & & \end{vmatrix} = 0 \tag{326}$$

Comparison of determinants (323) and (324) shows that if the first row and first column of (323) are removed, then the remainder of (323) is identical to (324). The significance of this observation is that if any one of the off-diagonal terms vanishes, that is **if  $Q(m) = 0$  for some integer  $m$  (positive, negative or zero), then coexistence can occur and an infinite number of possible tongues of instability will not occur.**

In order to understand how this works, suppose that  $Q(2) = 0$ . Then we may represent eqs.(323),(324) symbolically as follows:

$$a_{even} : \begin{vmatrix} X & X & 0 & 0 & 0 & & \\ X & X & X & 0 & 0 & & \\ 0 & X & X & X & 0 & \dots & \\ 0 & 0 & Q(2) & X & X & & \\ 0 & 0 & 0 & X & X & & \\ & & & \dots & & & \end{vmatrix} = 0 \tag{327}$$

$$b_{even} : \begin{vmatrix} X & X & 0 & 0 & & \\ X & X & X & 0 & & \\ 0 & Q(2) & X & X & \dots & \\ 0 & 0 & X & X & & \\ & & \dots & & & \end{vmatrix} = 0 \tag{328}$$

where we have used the symbol  $X$  to represent a term which is non-zero. The vanishing of  $Q(2)$  “disconnects” the lower (infinite) portion of these equations from the upper (finite) portion. There are now two possible ways in which to satisfy these equations with  $Q(2) = 0$ :

1. For a nontrivial solution to the lower (infinite) portion, the (disconnected, infinite) determinant must vanish. Since this determinant is identical for both the  $a$ 's and the  $b$ 's, coexistence is present and the associated tongues emanating from  $c = 36, 64, \dots$  do not occur. The coefficients  $a_6, a_8, a_{10}, \dots$  and  $b_6, b_8, b_{10}, \dots$  will not in general vanish. In this case the upper portion of the determinant will not vanish in general, and the coefficients  $a_0, a_2, a_4, b_2$  and  $b_4$  will not be zero because they depend respectively on  $a_6$  and  $b_6$ .

2. Another possibility is that the infinite determinant of the lower portion is not zero, requiring that the associated  $a_{even}$  and  $b_{even}$  coefficients vanish. With these  $a$ 's and  $b$ 's zero, the upper portion of the system beomes independent of the lower. For a nontrivial solution for  $a_0, a_2, a_4$ , the upper portion of determinant (327) must vanish, whereas for a nontrivial solution for  $b_2$  and  $b_4$ , the upper portion of determinant (328) must vanish. For eq.(327) this involves a  $3 \times 3$  determinant and yields a cubic on  $c$ , while for eq.(328) this involves a  $2 \times 2$  determinant and gives a quadratic on  $c$ . Together these yield 5 expressions for  $c$  in terms of the other parameters of the problem, which, if real, correspond to 5 transition curves. One of these passes through

the  $c$ -axis at  $c = 0$ , and the other 4 produce tongues of instability emanating from  $c = 4$  and  $c = 16$  respectively.

A similar story holds for equations (325) and (326). **If  $P(m) = 0$  for some integer  $m$  (positive, negative or zero), then only a finite number of tongues will occur from amongst the infinite set of tongues which emanate from the points  $c = (2n - 1)^2$ ,  $n = 1, 2, 3, \dots$  on the  $c$ -axis.**

As an example, let us return to eq.(305) for which  $a = b = \epsilon/2$  and  $d = 0$ . The polynomials  $Q(m)$  and  $P(m)$  become, from eqs.(321),(322):

$$Q(m) = \frac{d}{2} + bm - 2am^2 = \frac{\epsilon}{2}(m - 2m^2) = 0 \implies Q(0) = 0, Q(\frac{1}{2}) = 0 \quad (329)$$

$$P(m) = \frac{d + b(2m - 1) - a(2m - 1)^2}{2} = \frac{\epsilon}{4}[(2m - 1) - (2m - 1)^2] \implies P(1) = 0, P(\frac{1}{2}) = 0 \quad (330)$$

The important results here are that  $Q(0) = 0$  and  $P(1) = 0$ . When  $Q(0) = 0$  is substituted into eqs.(323),(324), we see that the element  $c$  in the upper left corner of (323) becomes disconnected from the rest of the infinite determinant, which is itself identical to the infinite determinant in (324). From this we may conclude that all the “even” tongues disappear.

And when  $P(1) = 0$  is substituted into eqs.(325),(326), we see that the element in the upper left corner of both (325) and (326) becomes disconnected from the rest of the infinite determinant, which itself is the same for both (325) and (326). From this we may conclude that only one “odd” tongue survives. It is bounded by the transition curves  $c = 1 \pm P(0) = 1 \pm \frac{\epsilon}{2}$ .

### 7.3 Designing a System with a Finite Number of Tongues

By choosing the coefficients  $a, b$ , and  $d$  in eq.(304) such that both  $Q(m)$  and  $P(m)$  have integer zeros, we may design a system which possesses a finite number of tongues of instability. For example let us take  $Q(-2) = 0$  and  $P(3) = 0$ . Since  $P(m) = Q(m - 1/2)$  from eq.(322),  $P(3) = Q(5/2) = 0$ , and we require a function  $Q(m)$  which has zeros  $m = -2, 5/2$ , i.e.  $Q(m) = (m + 2)(m - 5/2) = m^2 - m/2 - 5$ . Now since  $Q(m) = d/2 + bm - 2am^2$  from eq.(321), we may choose  $a = -\epsilon/2, b = -\epsilon/2$ , and  $d = -10\epsilon$ , producing the ode:

$$(1 - \frac{\epsilon}{2} \cos 2t) \frac{d^2x}{dt^2} - \frac{\epsilon}{2} \sin 2t \frac{dx}{dt} + (c - 10\epsilon \cos 2t) x = 0 \quad (331)$$

From the reasoning presented above, we see from eqs.(323) and (324) that  $Q(-2) = 0$  produces a single tongue emanating from the point  $c = 4, \epsilon = 0$ . Similarly we see from eqs.(325) and (326) that  $P(3) = 0$  produces 3 tongues emanating from the points  $c = 1, 9, 25, \epsilon = 0$ . Thus eq.(331) has 4 tongues of instability.

This result may be checked by generating series expansions for the transition curves and verifying that the tongue widths are zero for all tongues except for the 4 stated tongues. See Problem 2.

## 7.4 Application 1

In the Chapter on Mathieu's equation we saw that the stability of the x-mode of the particle in the plane was governed by the equation (see (230)):

$$\frac{d^2v}{dt^2} + \left( \frac{1 - L - A^2 \cos^2 t}{1 - A^2 \cos^2 t} \right) v = 0 \quad (332)$$

Multiplying (332) by  $1 - A^2 \cos^2 t$  and using a trig identity, we obtain:

$$\left( 1 - \frac{A^2}{2} - \frac{A^2}{2} \cos 2t \right) \frac{d^2v}{dt^2} + \left( 1 - L - \frac{A^2}{2} - \frac{A^2}{2} \cos 2t \right) v = 0 \quad (333)$$

Eq.(333) may be put in the form of Ince's equation (304) by dividing by  $1 - \frac{A^2}{2}$ , in which case we obtain the following expressions for the parameters  $a, b, c, d$ :

$$a = d = \frac{-\frac{A^2}{2}}{1 - \frac{A^2}{2}}, \quad b = 0, \quad c = \frac{1 - L - \frac{A^2}{2}}{1 - \frac{A^2}{2}} \quad (334)$$

Next we use eqs.(321) and (322) to compute  $Q(m)$  and  $P(m)$ :

$$Q(m) = \frac{d}{2} + bm - 2am^2 = a(-2m^2 + \frac{1}{2}) \implies Q(\frac{1}{2}) = 0, Q(-\frac{1}{2}) = 0 \quad (335)$$

$$P(m) = \frac{d + b(2m - 1) - a(2m - 1)^2}{2} = \frac{a}{2}(-2m + 1)^2 + 1 \implies P(0) = 0, P(1) = 0 \quad (336)$$

The important result here is that  $P(0) = 0$  and  $P(1) = 0$ . Inspection of eqs.(325) and (326) shows that the resulting linear algebraic equations on the coefficients  $a_{odd}$  are identical to those on  $b_{odd}$ , so that coexistence occurs for all solutions of period  $2\pi$ . Thus all the "odd" tongues are absent. On the other hand, since the zeros of  $Q(m)$  are not integers, we see that eq.(332) exhibits an infinite number of "even" tongues which are bounded by transition curves on which there exist solutions of period  $\pi$ .

## 7.5 Application 2

This example is taken from a paper by Pak, Rand and Moon, *Nonlinear Dynamics* **3**:347-364 (1992). A two degree of freedom system consists of a particle of mass  $m$  and a disk having moment of inertia  $J$ , which are respectively restrained by two linear springs and a linear torsion spring. As shown in the Figure, the equations of motion can be written in the form:

$$(1 + \epsilon y^2) \frac{d^2x}{dt^2} + 2\epsilon y \frac{dy}{dt} \frac{dx}{dt} + p^2 x = 0 \quad (337)$$

$$\frac{d^2y}{dt^2} - \epsilon \left( \frac{dx}{dt} \right)^2 y + y = 0 \quad (338)$$

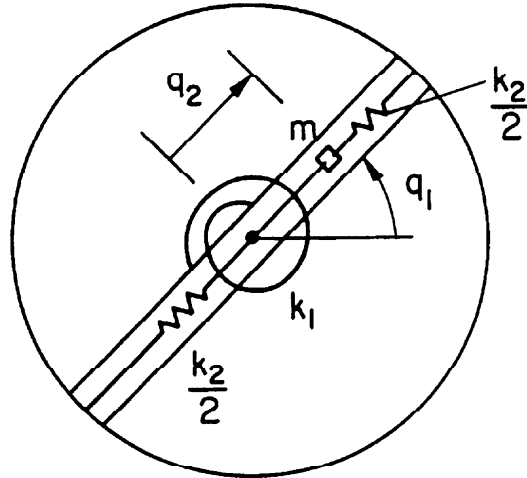

### Equations of Motion

From Figure 2, the kinetic and potential energies of system  $S$  are:

$$T = \frac{m}{2} [q_2^2 q_1'^2 + q_2'^2] + \frac{J}{2} q_1'^2, \quad (1)$$

$$V = \frac{1}{2} [k_1 q_1^2 + k_2 q_2^2], \quad (2)$$

where primes represent differentiation with respect to time  $\tau$ . Then setting

$$x = \sqrt{\frac{Jk_2}{m}} q_1, \quad y = \sqrt{k_2} q_2, \quad t = \sqrt{\frac{k_2}{m}} \tau, \quad (3)$$

we obtain the Lagrangian  $L$  in dimensionless coordinates:

$$L = \frac{1}{2} (1 + \epsilon y^2) \dot{x}^2 + \frac{1}{2} \dot{y}^2 - \frac{1}{2} (p^2 x^2 + y^2), \quad (4)$$

where

$$\epsilon = \frac{m}{Jk_2}, \quad p^2 = \frac{k_1 J}{k_2 m} \quad (5)$$

and where dots represent differentiation with respect to nondimensional time  $t$ . Note that  $p$  is the ratio of the frequencies of the linear normal modes, the torsional  $x$ -mode to the bending  $y$ -mode.

Lagrange's equations for equation (4) become:

$$\begin{aligned} (1 + \epsilon y^2) \ddot{x} + 2\epsilon y \dot{y} \dot{x} + p^2 x &= 0, \\ \ddot{y} - \epsilon \dot{x}^2 + y &= 0. \end{aligned} \quad (6)$$

This system has an exact solution called the  $y$ -mode:

$$y = A \sin t, \quad x = 0 \tag{339}$$

The stability of the  $y$ -mode is governed by the following linear variational equation:

$$\left(1 + \frac{\epsilon A^2}{2} - \frac{\epsilon A^2}{2} \cos 2t\right) \frac{d^2 u}{dt^2} + \epsilon A^2 \sin 2t \frac{du}{dt} + p^2 u = 0 \tag{340}$$

Eq.(340) can be put in the form of Ince’s equation (304) by dividing by  $1 + \frac{\epsilon A^2}{2}$ . The parameters  $a, b, c, d$  are found to be:

$$b = -2a = \frac{\epsilon A^2}{1 + \frac{\epsilon A^2}{2}}, \quad c = \frac{p^2}{1 + \frac{\epsilon A^2}{2}}, \quad d = 0 \tag{341}$$

Next we use eqs.(321) and (322) to compute  $Q(m)$  and  $P(m)$ :

$$Q(m) = \frac{d}{2} + bm - 2am^2 = -2a(m^2 + m) \implies Q(0) = 0, \quad Q(-1) = 0 \tag{342}$$

$$P(m) = \frac{d + b(2m - 1) - a(2m - 1)^2}{2} = \frac{-2a(2m - 1) - a(2m - 1)^2}{2} \implies P\left(\pm \frac{1}{2}\right) = 0 \tag{343}$$

The important result here is that  $Q(0) = 0$  and  $Q(-1) = 0$ . Inspection of eqs.(323) and (324) shows that  $c = 0$  is a transition curve, and that the linear equations on the other  $a_{even}$  coefficients are identical to those on the  $b_{even}$  coefficients, so that coexistence occurs for all solutions of period  $\pi$ . Thus all the “even” tongues are absent. On the other hand, since the zeros of  $P(m)$  are not integers, we see that eq.(340) exhibits an infinite number of “odd” tongues which are bounded by transition curves on which there exist solutions of period  $2\pi$ .

### 7.6 Application 3

This example involves an elastic pendulum, that is, a plane pendulum consisting of a mass  $m$  suspended under gravity  $g$  by a weightless elastic rod of unstretched length  $L$  and having spring constant  $k$ . Let the position of the mass be given by the polar coordinates  $r$  and  $\phi$ . Then the kinetic energy  $T$  and the potential energy  $V$  are given by:

$$T = \frac{m}{2} \left[ \left(\frac{dr}{dt}\right)^2 + r^2 \left(\frac{d\phi}{dt}\right)^2 \right] \tag{344}$$

$$V = \frac{k}{2}(r - L)^2 - mgr \cos \phi \tag{345}$$

Lagrange’s equations for this system are:

$$m \frac{d^2 r}{dt^2} - mr \left(\frac{d\phi}{dt}\right)^2 + k(r - L) - mg \cos \phi = 0 \tag{346}$$



$$mr^2 \frac{d^2\phi}{dt^2} + 2mr \frac{dr}{dt} \frac{d\phi}{dt} + mgr \sin \phi = 0 \tag{347}$$

Eqs.(346),(347) have an exact solution, the  $r$ -mode:

$$r = A \cos \omega t + L + \frac{mg}{k}, \quad \phi = 0, \quad \text{where} \quad \omega = \sqrt{\frac{k}{m}} \tag{348}$$

The stability of the  $r$ -mode is governed by the following linear variational equation:

$$(Ak \cos \omega t + mg + kL) \frac{d^2u}{dt^2} - 2Ak\omega \sin \omega t \frac{du}{dt} + gku = 0 \tag{349}$$

In order to put eq.(349) in the form of Ince's equation (304), we set

$$\omega t = 2\tau \tag{350}$$

which gives

$$(Ak \cos 2\tau + mg + kL) \frac{d^2u}{d\tau^2} - 4Ak\omega \sin 2\tau \frac{du}{d\tau} + \frac{4gk}{\omega^2} u = 0 \tag{351}$$

Eq.(351) can be put in the form of Ince's equation (304) by dividing by  $mg+kL$ . The parameters  $a, b, c, d$  are found to be:

$$a = -\frac{b}{4} = \frac{Ak}{mg+kL}, \quad c = \frac{4ag}{A\omega^2}, \quad d = 0 \tag{352}$$

Next we use eqs.(321) and (322) to compute  $Q(m)$  and  $P(m)$ :

$$Q(m) = \frac{d}{2} + bm - 2am^2 = -2a(m^2 + 2m) \implies Q(0) = 0, Q(-2) = 0 \tag{353}$$

$$P(m) = \frac{d + b(2m - 1) - a(2m - 1)^2}{2} = -2a(2m - 1) - \frac{a}{2}(2m - 1)^2 \implies P\left(\frac{1}{2}\right) = 0, P\left(-\frac{3}{2}\right) = 0 \tag{354}$$

The important result here is that  $Q(0) = 0$  and  $Q(-2) = 0$ . Inspection of eqs.(323) and (324) shows that  $c = 0$  is a transition curve, and that the linear equations on the other  $a_{even}$  coefficients are identical to those on the  $b_{even}$  coefficients, so that coexistence occurs for all solutions of period  $\pi$ . Thus all the "even" tongues are absent. Note that  $c = 4$  is an exact transition curve, but because of coexistence there is no associated tongue. On the other hand, since the zeros of  $P(m)$  are not integers, we see that eq.(351) exhibits an infinite number of "odd" tongues which are bounded by transition curves on which there exist solutions of period  $2\pi$ .

## 7.7 Problems

### Problem 7.1

In the following matrix equation, the elements  $x$  and  $y$  stand for generic real numbers:

$$\begin{bmatrix} x & x & & & & & & & \\ x & x & x & & & & & & \\ & x & x & a & & & & & \\ & & b & y & y & & & & \\ & & & y & y & y & & \dots & \\ & & & & y & y & y & & \\ & & & & & y & y & y & \\ & & & & & & y & y & y \\ \dots & & & & & & & & \dots \end{bmatrix} \begin{bmatrix} u_1 \\ u_2 \\ u_3 \\ v_1 \\ v_2 \\ v_3 \\ v_4 \\ v_5 \\ \dots \end{bmatrix} = 0 \tag{355}$$

Note that this equation can be written as the two equations:

$$\mathbf{X} \mathbf{u} = \begin{bmatrix} x & x \\ x & x & x \\ x & x \end{bmatrix} \begin{bmatrix} u_1 \\ u_2 \\ u_3 \end{bmatrix} = \begin{bmatrix} 0 \\ 0 \\ -av_1 \end{bmatrix} \tag{356}$$

$$\mathbf{Y} \mathbf{v} = \begin{bmatrix} y & y & & & & \\ y & y & y & & & \\ & y & y & y & & \dots \\ & & y & y & y & \\ & & & y & y & y \\ \dots & & & & & \dots \end{bmatrix} \begin{bmatrix} v_1 \\ v_2 \\ v_3 \\ v_4 \\ v_5 \\ \dots \end{bmatrix} = \begin{bmatrix} -bu_3 \\ 0 \\ 0 \\ 0 \\ 0 \\ \dots \end{bmatrix} \tag{357}$$

Note that if  $a = 0$  and  $b \neq 0$  then the  $\mathbf{X}$  equation (356) is uncoupled from the  $\mathbf{Y}$  equation (357), but the  $\mathbf{Y}$  equation still depends on the solution  $u_3$  of the  $\mathbf{X}$  equation. In this case there are two ways to satisfy these equations:

First way: If  $\det \mathbf{X} = 0$  then we will have a nontrivial solution for the  $\{u_i\}$ . Assuming  $\det \mathbf{Y} \neq 0$  and that  $u_3 \neq 0$ , we obtain a nontrivial solution for  $\{v_i\}$ .

Second way: If  $\det \mathbf{X} \neq 0$  then we will have a trivial solution for the  $\{u_i\}$ . The vanishing of  $u_3$  then requires that  $\det \mathbf{Y} = 0$  in order to obtain a nontrivial solution for  $\{v_i\}$ .

Note that in both ways we obtain a nontrivial solution for the  $\{v_i\}$ , that is, the solution of the original equation (355) will not have finite order. (A solution of an infinite system (355) is said to have finite order if all the solution elements  $\{u_i, v_i\}$  are zero except for a finite number of them.)

The opposite situation occurs if  $b = 0$  and  $a \neq 0$ . In that case it is the  $\mathbf{Y}$  equation (357) which is uncoupled from the  $\mathbf{X}$  equation (356). There are again two ways of satisfying the resulting equations:

First way: If  $\det \mathbf{Y} = \mathbf{0}$  then we will have a nontrivial solution for the  $\{v_i\}$ . Assuming  $\det \mathbf{X} \neq \mathbf{0}$  and that  $v_1 \neq 0$ , we obtain a nontrivial solution for  $\{u_i\}$ .

Second way: If  $\det \mathbf{Y} \neq \mathbf{0}$  then we will have a trivial solution for the  $\{v_i\}$ . The vanishing of  $v_1$  then requires that  $\det \mathbf{X} = \mathbf{0}$  in order to obtain a nontrivial solution for  $\{u_i\}$ .

Note that in the second way we obtain a solution of finite order.

Answer the following questions by referring to the equations (323)-(326):

- i. Show that coexistence will occur if  $Q(m) = 0$  or if  $P(m) = 0$  for some integer  $m$  (positive, negative or zero).
- ii. Show that a  $\pi$ -periodic or  $2\pi$ -periodic solution to Ince's equation (304) will not have a finite number of terms in its Fourier series (309) if  $m$  of the preceding question is a negative integer.

**Problem 7.2**

In the text, we designed the following differential equation (331) so that it had 4 tongues:

$$(1 - \frac{\epsilon}{2} \cos 2t) \frac{d^2x}{dt^2} - \frac{\epsilon}{2} \sin 2t \frac{dx}{dt} + (c - 10\epsilon \cos 2t) x = 0 \tag{358}$$

Our purpose here is to verify that this is true (at least for small  $\epsilon$ ) by directly computing series expansions for the various transition curves by the use of a perturbation method.

In the following explanation, we will, for clarity of presentation, focus on the transition curves through the point  $c = 4, \epsilon = 0$ . However, the treatment is easily generalized to any of the transition curves.

We expand  $c$  and  $x(t)$  in power series in  $\epsilon$ :

$$c = 4 + c_1 \epsilon + c_2 \epsilon^2 + c_3 \epsilon^3 + \dots \tag{359}$$

$$x(t) = \cos 2t + x_1(t) \epsilon + x_2(t) \epsilon^2 + x_3(t) \epsilon^3 + \dots \tag{360}$$

Substituting (359),(360) into (358) and collecting terms, we obtain a series of equations of the  $x_i(t)$ , the first two of which are:

$$\frac{d^2x_1}{dt^2} + 4x_1 + \sin^2(2t) - 8 \cos^2(2t) + c_1 \cos(2t) = 0 \tag{361}$$

$$\frac{d^2x_2}{dt^2} + 4x_2 - \frac{\cos(2t)}{2} \frac{d^2x_1}{dt^2} - \frac{\sin(2t)}{2} \frac{dx_1}{dt} - 10 \cos(2t) x_1 + c_1 x_1 + c_2 \cos(2t) = 0 \tag{362}$$

Trigonometrically reducing eq.(361) gives

$$\frac{d^2x_1}{dt^2} + 4x_1 = \frac{9 \cos(4t)}{2} - c_1 \cos(2t) + \frac{7}{2} \tag{363}$$

For no secular terms in  $x_1(t)$ , we must set  $c_1 = 0$ . Then we may obtain the following particular solution for  $x_1(t)$ :

$$x_1(t) = \frac{7}{8} - \frac{3 \cos(4t)}{8} \tag{364}$$

Next we substitute (364) and  $c_1 = 0$  into (362) and trigreduce the resulting equation to get:

$$\frac{d^2x_2}{dt^2} + 4x_2 = -\frac{3 \cos(6t)}{4} - c_2 \cos(2t) + \frac{35 \cos(2t)}{4} \tag{365}$$

For no secular terms in  $x_2(t)$ , we must set  $c_2 = \frac{35}{4}$ . Thus we have found the transition curve to have the form:

$$c = 4 + \frac{35}{4} \epsilon^2 + O(\epsilon^3) \tag{366}$$

In order to find a similar approximation for the other transition curve which emanates from  $c = 4, \epsilon = 0$ , we repeat the above procedure except we replace eq.(360) by

$$x(t) = \sin 2t + x_1(t) \epsilon + x_2(t) \epsilon^2 + x_3(t) \epsilon^3 + \dots \tag{367}$$

This turns out to give the following result for the transition curve:

$$c = 4 + O(\epsilon^3) \tag{368}$$

Incidentally, it turns out that in this case  $c = 4$  is the exact expression for the transition curve. Why?

Since the two expressions (366) and (368) are distinct, the tongue emanating from  $c = 4$  on the  $c$ -axis has not disappeared, in agreement with how we designed equation (358).

Proceed in this way and compute series expansions for the first 11 transition curves (6 even and 5 odd) out to  $O(\epsilon^{10})$ . This problem is best done using computer algebra. You should find that the pairs of transition curves emanating from  $c = 1, 4, 9$  and  $25$  are distinct, while the pairs coming from  $c = 16, 36, 49, 64, 81$  and  $100$  are identical (no tongues due to coexistence).

As a check on your work, here is the series which we computed, eq.(366), extended out to  $O(\epsilon^{10})$ :

$$c = 4 + \frac{35 \epsilon^2}{4} - \frac{1225 \epsilon^4}{64} + \frac{42875 \epsilon^6}{512} - \frac{7503125 \epsilon^8}{16384} + \frac{367653125 \epsilon^{10}}{131072} + \dots \tag{369}$$

## 8 Two Coupled Conservative Oscillators

This Chapter concerns the dynamics of a system of two coupled conservative oscillators. As an example, imagine a system consisting of two unit masses constrained to move on a straight line and restrained by two springs. One mass (coordinate  $x$ ) is restrained by an anchor spring. The second mass (coordinate  $y$ ) is connected to the first mass by a second spring. The system is driven by a force  $F \cos \omega t$  applied to the second mass (coordinate  $y$ ).

If the springs were linear, the problem would be solvable by the method of normal modes. This involves a coordinate transformation to normal coordinates which uncouples the unforced system into two simple harmonic oscillators. The independent motion of each of these uncoupled oscillators is called a normal mode, and the general solution of the linear system is a linear combination of the normal modes. To solve the forced system, one adds a particular solution to the general solution of the unforced system. If the normal modes of the unforced system have frequencies  $\omega_1$  and  $\omega_2$ , then the driven system exhibits resonances when the driving frequency  $\omega$  is close to either  $\omega_1$  or  $\omega_2$ .

If either or both of the springs are nonlinear, the foregoing scenario no longer works. In particular the general solution of the unforced system can no longer be written as a linear combination of normal modes because the principle of superposition no longer applies to the nonlinear system. Nevertheless, resonance in the forced nonlinear system occurs when the driving frequency is close to the frequency of one of the periodic motions of the unforced system, called *nonlinear normal modes*. We will use the abbreviation NNM for nonlinear normal mode.

$$\text{NNM} \quad = \quad \text{nonlinear normal mode}$$

The general motion of both the linear and nonlinear versions of the unforced example system is quasiperiodic. The NNMs of the nonlinear system are therefore special periodic motions which are analogous to the linear normal modes of the linear system. As the amplitude of the NNM becomes smaller, the nonlinear effects decrease and the motion approaches that of the linear normal mode. Thus the NNM can be thought of as an analytic continuation of the linear normal mode with the motion's amplitude as parameter.

### 8.1 Nonlinear Normal Modes

In order to see how this works, we study the example previously given. We assume the anchor spring is nonlinear with force-displacement relation:

$$f = \delta + \delta^3 \tag{370}$$

The second spring is assumed to be linear with characteristics  $f = \delta$ . The equations of motion are given by:

$$\frac{d^2x}{dt^2} + 2x - y + x^3 = 0, \quad \frac{d^2y}{dt^2} + y - x = F \cos \omega t \tag{371}$$

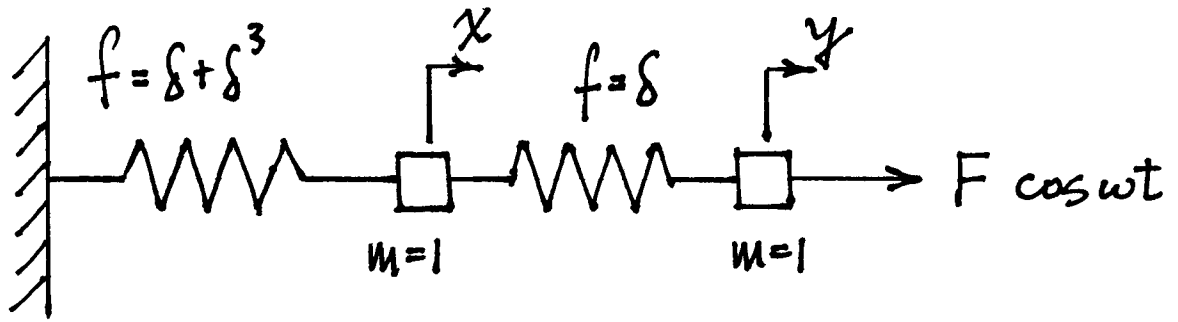

We are interested in a response at the forcing frequency. The method of harmonic balance offers an expedient approach here. Since there is no damping in this system, we expect no phase lag between the  $x$  and  $y$  motions, and we set:

$$x = A \cos \omega t, \quad y = B \cos \omega t \quad (372)$$

Substituting (372) into (371), trigreducing  $x^3$ , and setting the coefficients of  $\cos \omega t$  to zero, we obtain the following equations on  $A$  and  $B$ :

$$-\omega^2 A + 2A - B + \frac{3}{4}A^3 = 0, \quad -\omega^2 B + B - A = F \quad (373)$$

Solving the second eq. of (373) for  $B$  and substituting the result in the first eq. of (373), we get:

$$\omega^4 + \left(-3 - \frac{3}{4}A^2\right)\omega^2 + 1 + \frac{3}{4}A^2 - \frac{F}{A}, \quad B = \frac{A + F}{1 - \omega^2} \quad (374)$$

The first eq. of (374) can be used to make an amplitude-frequency plot of  $A$  versus  $\omega$  for a fixed value of  $F$ . A similar plot of  $B$  versus  $\omega$  can be obtained by solving the second eq. of (373) for  $A$  and substituting the result in the first eq. of (373). Such plots are the two degree of freedom version of the amplitude-frequency plot we saw previously in connection with the forced Duffing equation.

In the amplitude-frequency plots, the NNMs are obtained by setting  $F = 0$  in eqs.(374). For small values of  $A$ , the first eq. of (374) becomes

$$\omega^4 - 3\omega^2 + 1 = 0 \quad (375)$$

which gives the linear normal modal frequencies  $\omega_1^2 = \frac{3 - \sqrt{5}}{2}$ ,  $\omega_2^2 = \frac{3 + \sqrt{5}}{2}$ . Examination of the amplitude-frequency plots shows that *resonance in the forced system occurs in the neighborhood of the NNMs.*

The NNMs can be pictured as curves in the  $x$ - $y$  plane. If in the second eq. of (374) we set  $F = 0$  and let  $\omega$  take on one of the frequencies (375), we see that  $B$  is proportional to  $A$  for a linear normal mode. Eq.(372) shows that  $y/x$  is a constant that is independent of amplitude for a linear normal mode. Geometrically, this means that linear normal modes plot as straight line segments through the origin. In the case of a NNM,  $\omega$  depends on the amplitude  $A$ , and the second eq. of (374) predicts that the slope of the line segment corresponding to a NNM depends on the amplitude of vibration. Of course the assumed form of the solution (372), although exact for linear normal modes, is only an approximation for NNMs. The presence of higher harmonics will in general cause a NNM to plot as a *curved* line segment through the origin. The shape of the curved line segment which represents the NNM will typically change with amplitude of vibration. The endpoints of the line segments, curved or straight, represent places where the kinetic energy is zero.

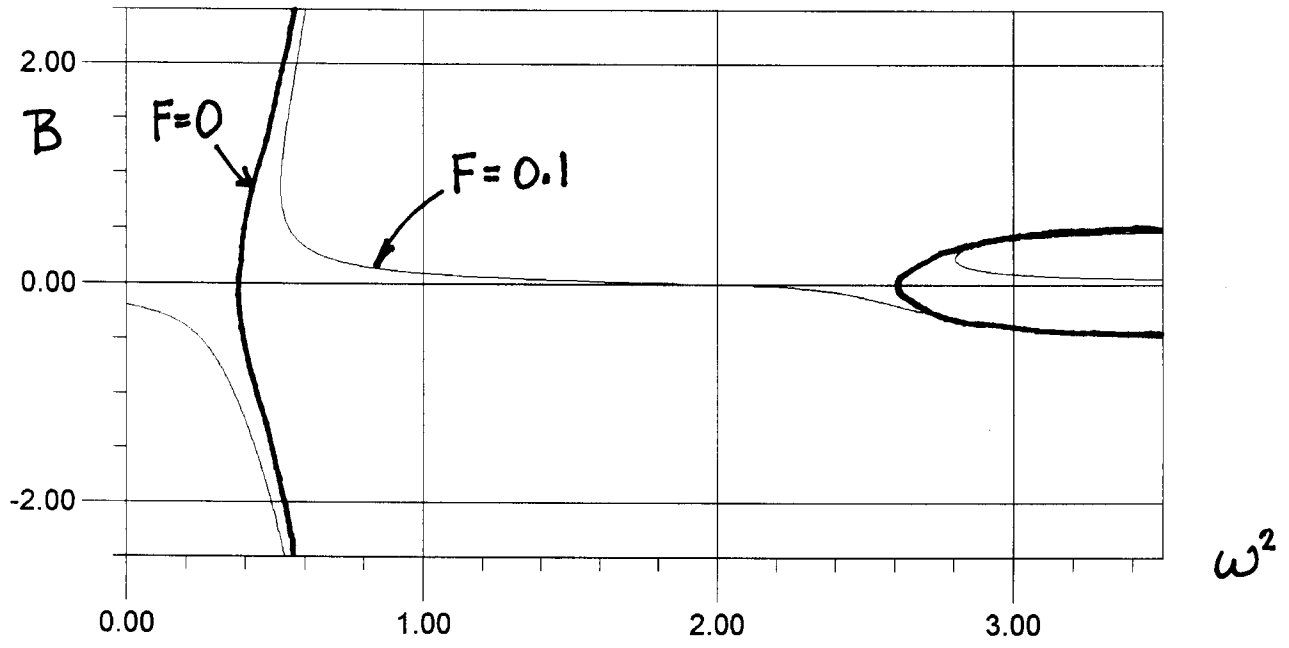
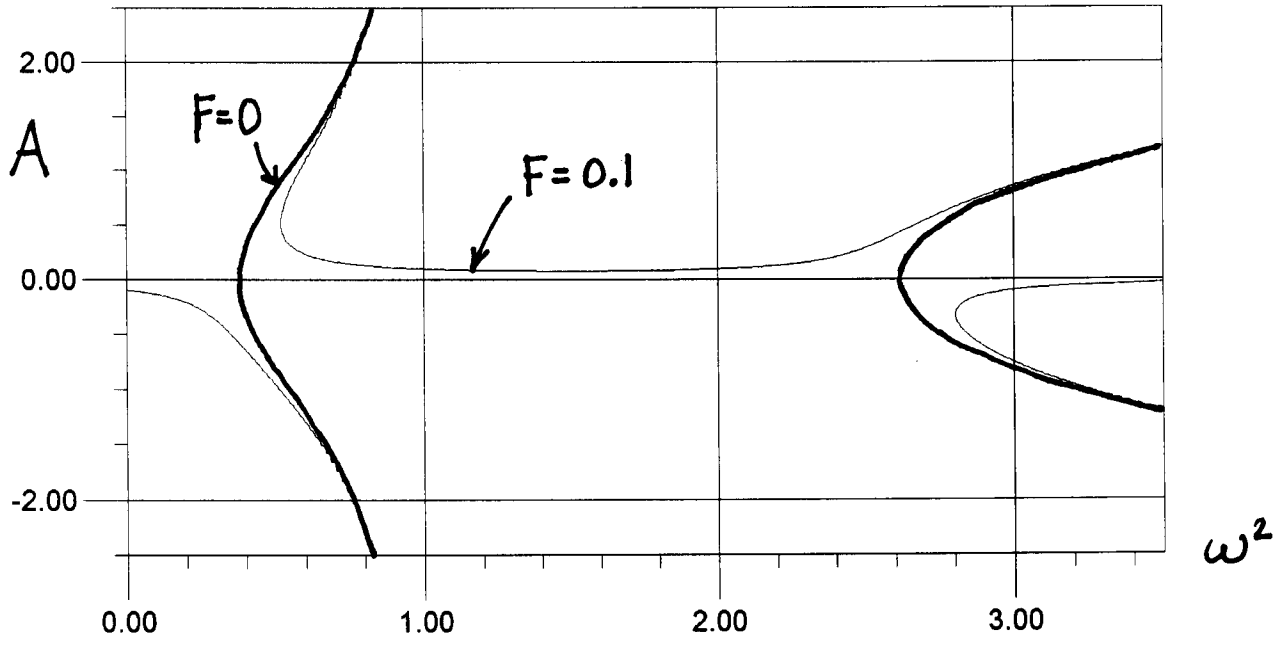



Both linear normal modes and NNMs share the following features:

- 1) Both  $x$  and  $y$  vanish simultaneously twice per cycle (corresponding to passage through the origin in the  $x$ - $y$  plane), and
- 2) Both  $dx/dt$  and  $dy/dt$  vanish simultaneously twice per cycle (corresponding to the endpoints of the line segments).

These observations led Rosenberg in the 1960's to define NNMs as *vibrations-in-unison*. See R.M.Rosenberg, "On Nonlinear Vibrations of Systems with Many Degrees of Freedom", in *Advances in Applied Mechanics*, Academic Press, 1966, pp.155-242.

If the amplitude is allowed to vary, then the locus of the endpoints of the line segments of the NNMs will form a curve in the  $x$ - $y$  plane. Points on this curve correspond to initial conditions on  $x$  and  $y$  such that a NNM results when the system is released from rest at one of these points. This curve is called a *Grenzkurve* after H.Kauderer's "Nichtlineare Mechanik", Springer, 1958, pp.593-612.

A recent reference on NNMs is "Normal Modes and Localization in Nonlinear Systems" by Vakakis, Manevitch, Mikhlin, Pilipchuk and Zevin, Wiley, 1996.

## 8.2 The Modal Equation

Since a NNM plots as a simple curve in the  $x$ - $y$  plane, we are motivated to seek this curve by considering  $y$  as a function of  $x$ , without direct reference to time  $t$ . In order to generalize the treatment, we begin with a conservative system in the form:

$$\frac{d^2x}{dt^2} = -\frac{\partial V}{\partial x}, \quad \frac{d^2y}{dt^2} = -\frac{\partial V}{\partial y} \quad (376)$$

where  $V = V(x, y)$  is the potential energy. Eqs.(376) possess the first integral:

$$\frac{1}{2} \left[ \left( \frac{dx}{dt} \right)^2 + \left( \frac{dy}{dt} \right)^2 \right] + V(x, y) = h \quad (377)$$

where  $h$  is the total energy and is determined by the initial conditions. We are interested in transforming from  $x(t)$  and  $y(t)$  to  $y(x)$ . To do so we use the chain rule:

$$\frac{dy}{dt} = \frac{dy}{dx} \frac{dx}{dt}, \quad \frac{d^2y}{dt^2} = \frac{d^2y}{dx^2} \left( \frac{dx}{dt} \right)^2 + \frac{dy}{dx} \frac{d^2x}{dt^2} \quad (378)$$

Substituting (376) into the second of (378),

$$-\frac{\partial V}{\partial y} = \frac{d^2y}{dx^2} \left( \frac{dx}{dt} \right)^2 - \frac{dy}{dx} \frac{\partial V}{\partial x} \quad (379)$$

Next we substitute the first of (378) into (377):

$$\frac{1}{2} \left( \frac{dx}{dt} \right)^2 \left( 1 + \left( \frac{dy}{dx} \right)^2 \right) + V(x, y) = h \quad (380)$$

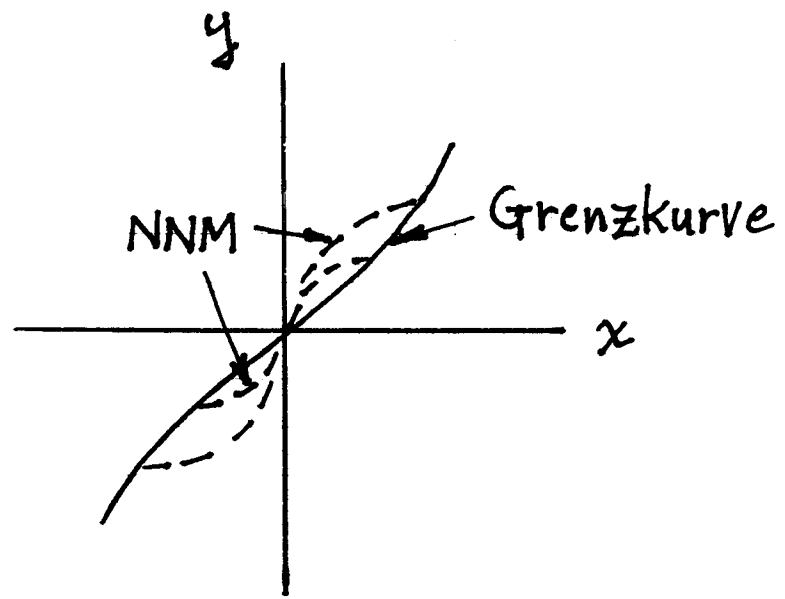

Finally we solve (380) for  $\left(\frac{dx}{dt}\right)^2$  and substitute into (379), giving the equation:

$$2(h - V) \frac{d^2y}{dx^2} + \left(1 + \left(\frac{dy}{dx}\right)^2\right) \left(\frac{\partial V}{\partial y} - \frac{dy}{dx} \frac{\partial V}{\partial x}\right) = 0 \quad (381)$$

Eq.(381) is a second order nonlinear o.d.e. on  $y$  as a function of  $x$  and is called the *modal equation*.

As an example of its use, we take a system consisting of two unit masses constrained to move along a straight line and restrained by two anchor springs and a coupling spring. We assume the identical anchor springs to be nonlinear with force-displacement relation:

$$f = \delta + K\delta^3 \quad (382)$$

where  $K$  is a parameter. The coupling spring is assumed to be strictly nonlinear with characteristic  $f = \delta^3$ . If the masses have coordinates  $x$  and  $y$ , the potential energy  $V$  becomes:

$$V(x, y) = \frac{1}{2}x^2 + \frac{1}{4}Kx^4 + \frac{1}{4}(x - y)^4 + \frac{1}{2}y^2 + \frac{1}{4}Ky^4 \quad (383)$$

As we have stated above, NNMs generally plot as curved line segments in the  $x$ - $y$  plane. Nevertheless, some problems exhibit NNMs which plot as straight line segments, called *similar normal modes* by Rosenberg. We may look for such similar normal modes by substituting  $y = Cx$  in the model equation (381), with  $V$  as in (383). This gives:

$$\frac{\partial V}{\partial y} - \frac{dy}{dx} \frac{\partial V}{\partial x} = -x^3(1 - C)^3 + Cx + KC^3x^3 - C(x + Kx^3 + x^3(1 - C)^3) = 0 \quad (384)$$

which simplifies to:

$$C^4 + (K - 2)(C^3 - C) - 1 = 0 \quad (385)$$

Solving (385) for  $C$ , we find:

$$C = 1, -1, 1 - \frac{K}{2} \pm \frac{\sqrt{K(K - 4)}}{2} \quad (386)$$

When  $K \leq 4$  there are only two similar normal modes,  $y = \pm x$ . An additional pair of similar normal modes exists when  $K > 4$ , having bifurcated out of the  $y = -x$  mode at  $K = 4$ .

Each of these similar normal modes is a two dimensional *invariant manifold* in the four dimensional phase space. That is, if the initial conditions on  $x, y, dx/dt$  and  $dy/dt$  satisfy the equation of a similar normal mode, then the motion stays on that invariant manifold for all time. This feature can be used to reduce the dimension of the system and simplify the analysis of such motions. For example, take the case of the in-phase mode  $y = x$ . The frequency of this mode may be obtained by treating the flow on the two dimensional invariant manifold. This is accomplished by writing out the  $x$  differential equation and substituting  $y = x$  to get a single second order equation on  $x$  only:

$$\frac{d^2x}{dt^2} = -\frac{\partial V}{\partial x} = -x - Kx^3 - (x - y)^3, \quad \text{or} \quad \frac{d^2x}{dt^2} + x + Kx^3 = 0 \quad \text{on } y = x \quad (387)$$

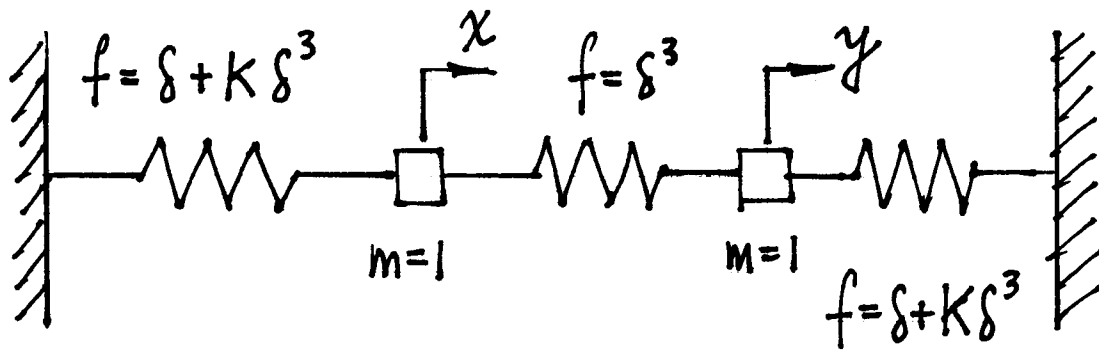

Bifurcation of Similar Normal Modes ( $y=Cx$ )

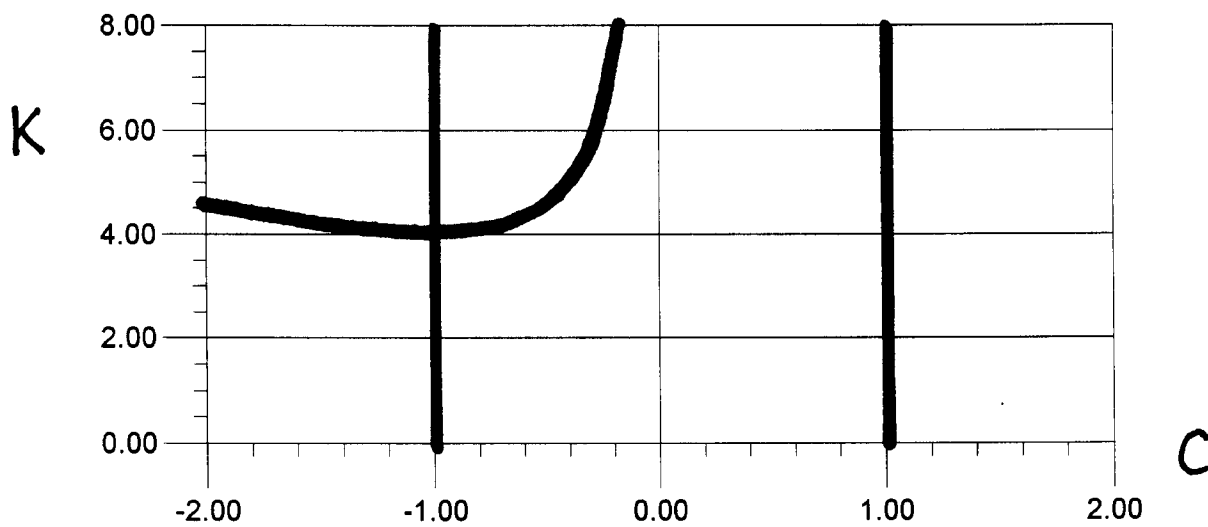

This is a Duffing equation which we have seen has the approximate frequency-amplitude relation (valid for small  $A$ ):

$$\omega = 1 + \frac{3}{8}KA^2 + \dots \quad (388)$$

where  $\omega$  is the motion's frequency and  $A$  is its amplitude.

### 8.3 Problems

#### Problem 8.1

Modal equation in a rotating coordinate system. If the  $x$ - $y$  coordinate system is rotating relative to a Newtonian frame with angular speed  $\omega$ , the presence of Coriolis and centripetal accelerations produces the following differential equations (comparable to eqs.(376)):

$$\frac{d^2x}{dt^2} - 2\omega\frac{dy}{dt} - \omega^2x = -\frac{\partial V}{\partial x}, \quad \frac{d^2y}{dt^2} + 2\omega\frac{dx}{dt} - \omega^2y = -\frac{\partial V}{\partial y} \quad (389)$$

For this system, obtain a first integral, comparable to (377), and using it, obtain a modal equation for the orbits in  $x$ - $y$  configuration space which does not involve time  $t$ . This will be an equation for  $y$  as a function of  $x$ , comparable to (381).

## 9 Two Coupled Limit Cycle Oscillators

A limit cycle oscillator, such as the van der Pol oscillator, is capable of autonomously generating an attractive periodic motion. This Chapter concerns what happens if we couple two such oscillators together. A contemporary example involves the interaction of two lasers. A laser is an oscillator that produces a coherent beam of light. If two lasers operate physically near one another, the light from either one of them can influence the behavior of the other. Although both oscillators will in general have different frequencies, the effect of the coupling may be to produce a motion which is phase and frequency locked.

We will distinguish between three states of a system of two coupled limit cycle oscillators: strongly locked, weakly locked and unlocked. The motion will be said to be *strongly locked* if it is both frequency locked and phase locked. If the motion is frequency locked (on the average) but the relative phase of the oscillators is not constant, we will say the system is *weakly locked*. If the frequencies are different (on the average) then we will say the system is *unlocked* or *drifting*.

### 9.1 Two Coupled van der Pol Oscillators

In this section we investigate the dynamics of a pair of coupled van der Pol oscillators in the small  $\epsilon$  limit:

$$\frac{d^2x}{dt^2} + x - \epsilon(1 - x^2)\frac{dx}{dt} = \epsilon\alpha(y - x) \quad (390)$$

$$\frac{d^2y}{dt^2} + (1 + \epsilon\Delta)y - \epsilon(1 - y^2)\frac{dy}{dt} = \epsilon\alpha(x - y) \quad (391)$$

where  $\epsilon$  is small, where  $\Delta$  is a parameter relating to the difference in uncoupled frequencies, and where  $\alpha$  is a coupling constant.

We use the two variable expansion method to obtain a slow flow. Working to  $O(\epsilon)$ , we set  $\xi = (1 + k_1\epsilon)t$ ,  $\eta = \epsilon t$  and we expand  $x = x_0 + \epsilon x_1$  and  $y = y_0 + \epsilon y_1$  giving:

$$\frac{\partial^2 x_0}{\partial \xi^2} + x_0 = 0 \quad (392)$$

$$\frac{\partial^2 y_0}{\partial \xi^2} + y_0 = 0 \quad (393)$$

$$\frac{\partial^2 x_1}{\partial \xi^2} + x_1 = -2\frac{\partial^2 x_0}{\partial \xi \partial \eta} - 2k_1\frac{\partial^2 x_0}{\partial \xi^2} + (1 - x_0^2)\frac{\partial x_0}{\partial \xi} + \alpha(y_0 - x_0) \quad (394)$$

$$\frac{\partial^2 y_1}{\partial \xi^2} + y_1 = -2\frac{\partial^2 y_0}{\partial \xi \partial \eta} - 2k_1\frac{\partial^2 y_0}{\partial \xi^2} - \Delta y_0 + (1 - y_0^2)\frac{\partial y_0}{\partial \xi} + \alpha(x_0 - y_0) \quad (395)$$

We take the general solution to eqs.(392),(393) in the form:

$$x_0(\xi, \eta) = A(\eta) \cos \xi + B(\eta) \sin \xi, \quad y_0(\xi, \eta) = C(\eta) \cos \xi + D(\eta) \sin \xi \quad (396)$$

Removing resonant terms in eqs.(394),(395), we obtain the following slow flow:

$$2\frac{dA}{d\eta} = -2k_1B + A - \frac{A}{4}(A^2 + B^2) + \alpha(B - D) \quad (397)$$

$$2\frac{dB}{d\eta} = 2k_1A + B - \frac{B}{4}(A^2 + B^2) + \alpha(C - A) \quad (398)$$

$$2\frac{dC}{d\eta} = -2k_1D + \Delta D + C - \frac{C}{4}(C^2 + D^2) + \alpha(D - B) \quad (399)$$

$$2\frac{dD}{d\eta} = 2k_1C - \Delta C + D - \frac{D}{4}(C^2 + D^2) + \alpha(A - C) \quad (400)$$

Eqs.(397)-(400) can be simplified by using polar coordinates  $R_i$  and  $\theta_i$ :

$$A = R_1 \cos \theta_1, \quad B = R_1 \sin \theta_1, \quad C = R_2 \cos \theta_2, \quad D = R_2 \sin \theta_2 \quad (401)$$

which gives the following expressions for  $x_0$  and  $y_0$ , from (396):

$$x_0(\xi, \eta) = R_1(\eta) \cos(\xi - \theta_1(\eta)) \quad y_0(\xi, \eta) = R_2(\eta) \cos(\xi - \theta_2(\eta)) \quad (402)$$

Substituting (401) into (397)-(400) gives:

$$2\frac{dR_1}{d\eta} = R_1 \left( 1 - \frac{R_1^2}{4} \right) + \alpha R_2 \sin(\theta_1 - \theta_2) \quad (403)$$

$$2\frac{dR_2}{d\eta} = R_2 \left( 1 - \frac{R_2^2}{4} \right) - \alpha R_1 \sin(\theta_1 - \theta_2) \quad (404)$$

$$2\frac{d\theta_1}{d\eta} = 2k_1 - \alpha + \frac{\alpha R_2 \cos(\theta_1 - \theta_2)}{R_1} \quad (405)$$

$$2\frac{d\theta_2}{d\eta} = 2k_1 - \Delta - \alpha + \frac{\alpha R_1 \cos(\theta_1 - \theta_2)}{R_2} \quad (406)$$

This system of 4 slow flow o.d.e.'s can be reduced to a system of 3 o.d.e.'s by defining  $\phi$  to be the phase difference between the  $x$  and  $y$  oscillators,  $\phi = \theta_1 - \theta_2$ :

$$2\frac{dR_1}{d\eta} = R_1 \left( 1 - \frac{R_1^2}{4} \right) + \alpha R_2 \sin \phi \quad (407)$$

$$2\frac{dR_2}{d\eta} = R_2 \left( 1 - \frac{R_2^2}{4} \right) - \alpha R_1 \sin \phi \quad (408)$$

$$2\frac{d\phi}{d\eta} = \Delta + \alpha \cos \phi \left( \frac{R_2}{R_1} - \frac{R_1}{R_2} \right) \quad (409)$$

We seek equilibrium points of the slow flow (407)-(409). These represent strongly locked periodic motions of the original system (390),(391). We multiply eq.(407) by  $R_1$  and (408) by  $R_2$  and add to get

$$R_1^2 + R_2^2 - \left( \frac{R_1^4 + R_2^4}{4} \right) = 0 \quad (410)$$

Next we multiply eq.(407) by  $R_2$  and (408) by  $R_1$  and subtract to get

$$\sin \phi = \frac{R_1 R_2 (R_1^2 - R_2^2)}{4\alpha(R_1^2 + R_2^2)} \tag{411}$$

Now we use (409) to solve for  $\cos \phi$ :

$$\cos \phi = \frac{R_1 R_2 \Delta}{\alpha(R_1^2 - R_2^2)} \tag{412}$$

Using the identity  $\sin^2 \phi + \cos^2 \phi = 1$  in (411),(412) and setting

$$P = R_1^2 + R_2^2, \quad \text{and} \quad Q = R_1^2 - R_2^2 \tag{413}$$

we get:

$$Q^6 - P^2 Q^4 + (16 \Delta^2 + 64 \alpha^2) P^2 Q^2 - 16 \Delta^2 P^4 = 0 \tag{414}$$

Using the  $P$  and  $Q$  notation of (413), eq.(410) becomes:

$$Q^2 = 8P - P^2 \tag{415}$$

Substituting (415) into (414), we get

$$P^3 - 20 P^2 + P (16 \Delta^2 + 32 \alpha^2 + 128) - (64 \Delta^2 + 256 \alpha^2 + 256) = 0 \tag{416}$$

Using Descartes' Rule of Signs, we see that (416) has either 1 or 3 positive roots for  $P$ . At bifurcation, there will be a double root which corresponds to requiring the derivative of (416) to vanish:

$$3 P^2 - 40 P + 16 \Delta^2 + 32 \alpha^2 + 128 = 0 \tag{417}$$

Eliminating  $P$  from eqs.(416) and (417) gives the condition for saddle-node bifurcations as:

$$\Delta^6 + (6 \alpha^2 + 2) \Delta^4 + (12 \alpha^4 - 10 \alpha^2 + 1) \Delta^2 + 8 \alpha^6 - \alpha^4 = 0 \tag{418}$$

Eq.(418) plots as two curves intersecting at a cusp in the  $\Delta$ - $\alpha$  plane. At the cusp, a further degeneracy occurs and there is a triple root in eq.(416). Requiring the derivative of (417) to vanish gives  $P = 20/3$  at the cusp, which gives the location of the cusp as:

$$\Delta = \frac{1}{\sqrt{27}} \approx 0.1924, \quad \alpha = \frac{2}{\sqrt{27}} \approx 0.3849 \tag{419}$$

Next we look for Hopf bifurcations in the slow flow system (407)-(409). The presence of a stable limit cycle in the slow flow surrounding an unstable equilibrium point, as occurs in a supercritical Hopf, represents a weakly locked quasiperiodic motion in the original system (390),(391). Let  $(R_{10}, R_{20}, \phi_0)$  be an equilibrium point. The behavior of the system linearized in the neighborhood of this point is determined by the eigenvalues of the Jacobian matrix:

$$\frac{1}{2} \begin{pmatrix} -\frac{3R_{10}^2-4}{4} & \alpha \sin \phi_0 & \alpha \cos \phi_0 R_{20} \\ -\alpha \sin \phi_0 & -\frac{3R_{20}^2-4}{4} & -\alpha \cos \phi_0 R_{10} \\ -\frac{\alpha \cos \phi_0 (R_{20}^2+R_{10}^2)}{R_{10}^2 R_{20}} & \frac{\alpha \cos \phi_0 (R_{20}^2+R_{10}^2)}{R_{10} R_{20}^2} & -\frac{\alpha \sin \phi_0 (R_{20}^2-R_{10}^2)}{R_{10} R_{20}} \end{pmatrix} \tag{420}$$



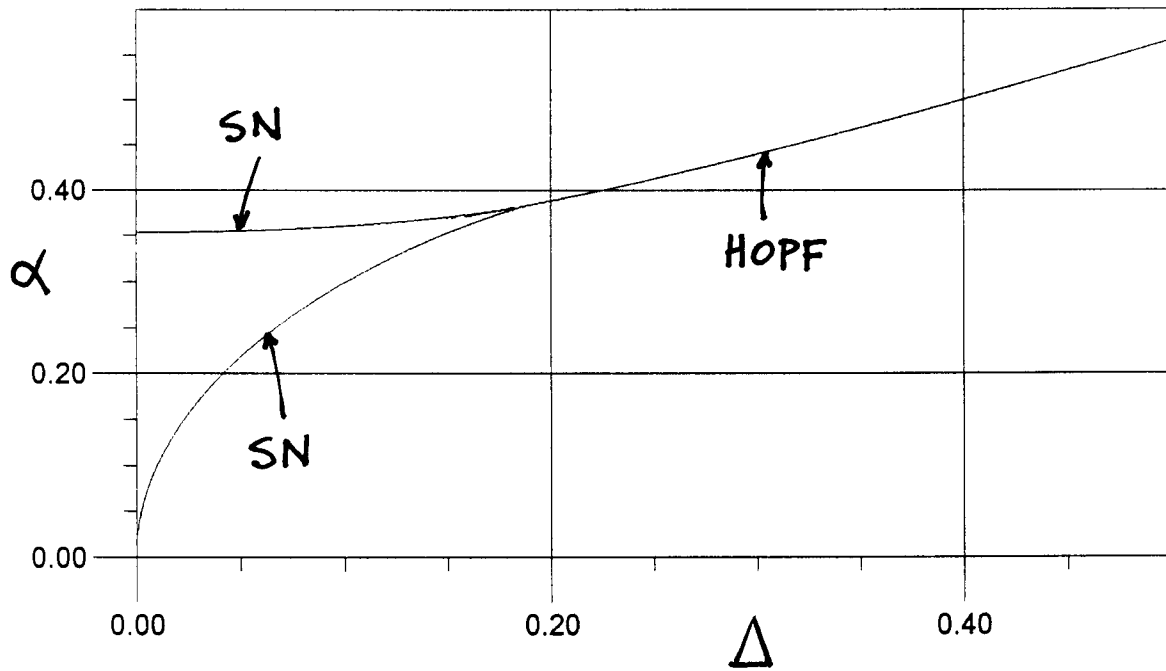

SN = saddle-node

BLOWUP OF CUSP REGION:

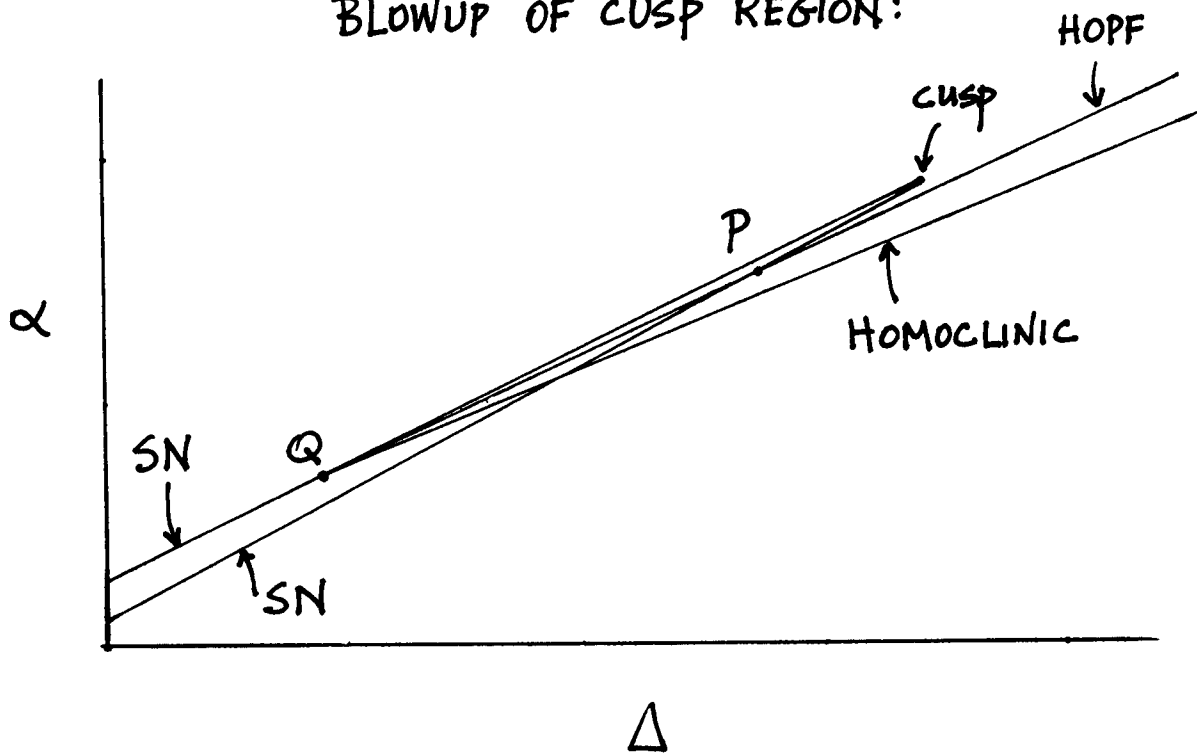

This matrix may be simplified by using eqs.(411) and (412) to replace  $\sin \phi_0$  and  $\cos \phi_0$ , and then using eqs.(413) to replace  $R_{10}$  and  $R_{20}$  by  $P$  and  $Q$ , and then using eq.(415) to replace  $Q$ . This turns out to give the following cubic equation on the eigenvalues  $\lambda$  of the matrix (420):

$$\lambda^3 + C_2\lambda^2 + C_1\lambda + C_0 = 0 \tag{421}$$

where  $C_2 = \frac{P - 4}{2}$  (422)

$$C_1 = \frac{7P^3 - 112P^2 + (-16\Delta^2 + 512)P - 512}{64P - 512} \tag{423}$$

$$C_0 = \frac{P^4 - 22P^3 + 160P^2 - (32\Delta^2 + 384)P}{128P - 1024} \tag{424}$$

For a Hopf bifurcation, the eigenvalues  $\lambda$  will include a pure imaginary pair,  $\pm i\beta$ , and a real eigenvalue,  $\gamma$ . This requires the characteristic equation to have the form:

$$\lambda^3 - \gamma\lambda^2 + \beta^2\lambda - \beta^2\gamma = 0 \tag{425}$$

Comparing eqs.(420) and (425), we see that a necessary condition for a Hopf is:

$$C_0 = C_1 C_2 \Rightarrow 3P^4 - 59P^3 + (-8\Delta^2 + 400)P^2 + (48\Delta^2 - 1088)P + 1024 = 0 \tag{426}$$

Eliminating  $P$  between eqs.(426) and (418) gives the condition for a Hopf as:

$$49\Delta^8 + (266\alpha^2 + 238)\Delta^6 + (88\alpha^4 + 758\alpha^2 + 345)\Delta^4 + (-1056\alpha^6 + 1099\alpha^4 + 892\alpha^2 + 172)\Delta^2 - 1152\alpha^8 - 2740\alpha^6 - 876\alpha^4 + 16 = 0 \tag{427}$$

This curve (427) intersects the lower curve of saddle-node bifurcations, eq.(418), at a point we shall refer to as point  $P$ , and it intersects and is tangent to the upper curve of saddle-node bifurcations at a point we shall refer to as point  $Q$ :

$$P : \Delta \approx 0.1918, \quad \alpha \approx 0.3846, \quad Q : \Delta \approx 0.1899, \quad \alpha \approx 0.3837 \tag{428}$$

We may obtain the asymptotic behavior of the curve (427) for large  $\Delta$  and large  $\alpha$  by keeping only the highest order terms in (427):

$$49\Delta^8 + 266\alpha^2\Delta^6 + 88\alpha^4\Delta^4 - 1056\alpha^6\Delta^2 - 1152\alpha^8 = 0 \tag{429}$$

which may be factored to give:

$$(\Delta^2 - 2\alpha^2)(\Delta^2 + 4\alpha^2)(7\Delta^2 + 12\alpha^2)^2 = 0 \tag{430}$$

which gives the asymptotic behavior:

$$\Delta \sim \sqrt{2}\alpha \tag{431}$$

So far the story is very similar to that of the forced van der Pol oscillator discussed in Chapter 5. However, there is an additional bifurcation here which did not occur in the forced problem.

There is a *homoclinic bifurcation* which occurs along a curve emanating from point  $Q$ . This involves the destruction of the limit cycle which was born in the Hopf. The limit cycle grows in size until it gets so large that it hits a saddle, and disappears in a saddle connection. For points on this curve far from point  $Q$ , we find that the limit cycle changes its topology into a closed curve in which  $\phi$  changes by  $2\pi$  each time around. Such a motion represents drift or unlocked behavior in the original system (390),(391). Unfortunately we do not have an analytic expression for the curve of homoclinic bifurcations.

In summary, we see that the transition from strongly locked behavior to unlocked behavior involves an intermediate state in which the system is weakly locked. In the three dimensional slow flow space, we go from a stable equilibrium point (strongly locked), to a stable limit cycle (weakly locked), and finally to a periodic motion which is topologically distinct from the original limit cycle (unlocked). As in the case of the forced van der Pol oscillator, in order for strongly locked behavior to occur, we need either a small difference in uncoupled frequencies (small  $\Delta$ ), or a large coupling constant  $\alpha$ . (The interested reader is referred to the doctoral thesis of T.Chakraborty, "Bifurcation Analysis of Two Weakly Coupled van der Pol Oscillators", Cornell University, 1987, for more information. See also "The Transition from Phase Locking to Drift in a System of Two Weakly Coupled van der Pol Oscillators" by Chakraborty and Rand in *International J. Non-Linear Mechanics*, 1988, pp.369-376.)

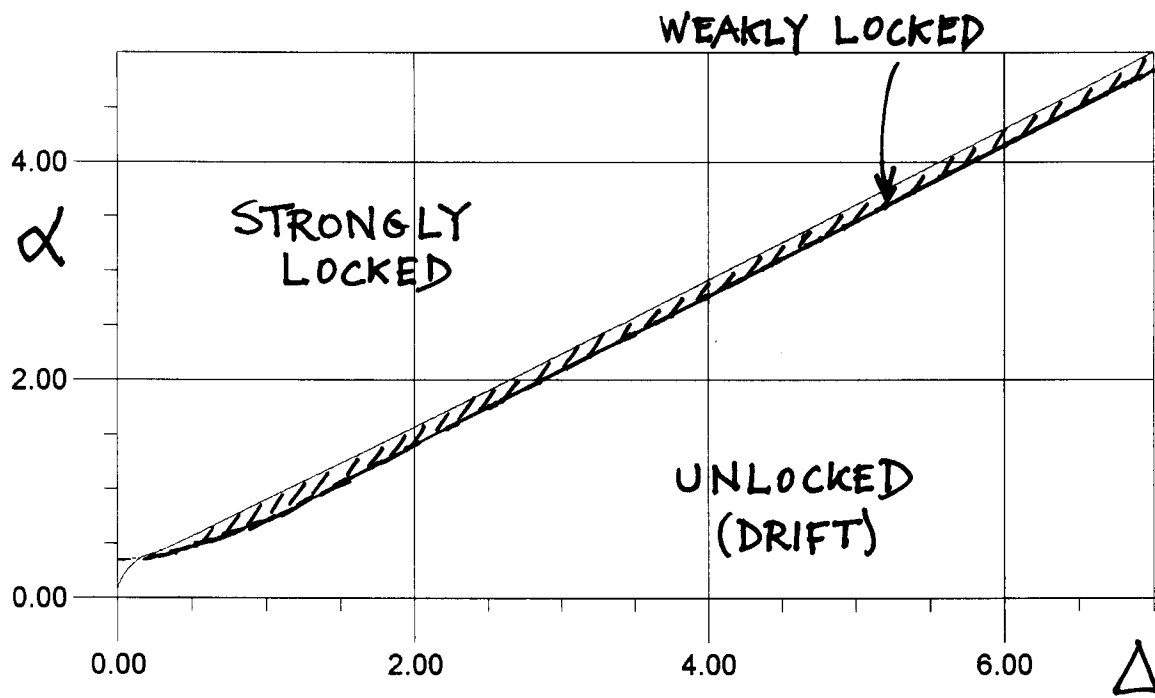

## 10 Center Manifolds

Imagine a situation in which a system of coupled oscillators has an asymptotically stable equilibrium point which becomes unstable as a parameter is tuned. This would happen, for example, if a pair of eigenvalues of the linearized system were to cross the imaginary axis. In the case of a single oscillator this would produce a Hopf bifurcation in which a limit cycle would typically be born as the equilibrium changes its stability. In the system of coupled oscillators, we might expect a similar bifurcation to occur, localized to the part of the space spanned by the eigenvectors corresponding to the pair of unstable eigenvalues. The intuitive reason for expecting this is that the motion in the other directions near the equilibrium point corresponds to eigenvalues with negative real parts and hence damps out.

This expectation can be justified by means of the center manifold theorem which states that there exists a (generally curved) subspace (the center manifold) which is tangent to the (flat) subspace spanned by the eigenvectors corresponding to those eigenvalues with zero real part, and which is invariant under the flow generated by the nonlinear equations. All solutions starting sufficiently close to the equilibrium point will tend asymptotically towards the center manifold. The stability of the equilibrium point in the full nonlinear equations will be the same as its stability in the flow on the center manifold. Any bifurcations which occur in the neighborhood of the equilibrium point on the center manifold are guaranteed to also occur in the full nonlinear system.

This theorem is the basis of a calculation in which we obtain an approximate expression for center manifold in the form of a power series, and then use this result to reduce the dimension of the system which we need to study. This can be an important alternative to the direct approach, especially if the system consists of many equations.

The reader interested in a proof of the center manifold theorem is referred to “Applications of Centre Manifold Theory” by J.Carr, Springer Verlag, 1981.

### 10.1 Example

As an example we take the following system of two coupled oscillators:

$$\frac{d^2x}{dt^2} - c\frac{dx}{dt} + x + x^2\frac{dx}{dt} = \alpha xy \quad (432)$$

$$\frac{d^2y}{dt^2} + \frac{dy}{dt} + y = x^2 \quad (433)$$

Eqs.(432),(433) may be described as a limit cycle oscillator  $x$  which is quadratically coupled to a damped linear oscillator  $y$ . Here  $\alpha$  is a coupling parameter.

Note that the  $x$  oscillator, when uncoupled from the  $y$  oscillator, exhibits a Hopf bifurcation at  $c = 0$ :

$$\frac{d^2x}{dt^2} - c\frac{dx}{dt} + x + x^2\frac{dx}{dt} = 0 \quad (434)$$

We may use the results obtained in Chapter 3 to determine the nature of the Hopf in eq.(434). Let us rewrite eq.(99) in the form:

$$\frac{d^2z}{dt^2} + z = c \frac{dz}{dt} + \beta_1 z^3 + \beta_2 z^2 \frac{dz}{dt} + \beta_3 z \left( \frac{dz}{dt} \right)^2 + \beta_4 \left( \frac{dz}{dt} \right)^3 \quad (435)$$

Then we saw in eq.(109) that eq.(435) exhibits a limit cycle if the following expression for its amplitude  $A$  is real:

$$A = 2 \sqrt{\frac{-c}{\beta_2 + 3\beta_4}} \quad (436)$$

Eq.(434) is of the form of eq.(435) with  $\beta_2 = -1$  and  $\beta_1 = \beta_3 = \beta_4 = 0$ . Thus eq.(436) predicts that

**the uncoupled  $x$  oscillator, eq.(434), exhibits a limit cycle of amplitude  $2\sqrt{c}$  for  $c > 0$ .**

Since the equilibrium in (434) is unstable when  $c > 0$ , the limit cycle is predicted to be stable and the Hopf is supercritical.

Now the question that we are interested in investigating here is: what is the effect of coupling the limit cycle  $x$  oscillator to the damped linear  $y$  oscillator in eqs.(432),(433)? We begin by rewriting these equations as a first order system:

$$\frac{dx_1}{dt} = x_2 \quad (437)$$

$$\frac{dx_2}{dt} = -x_1 + cx_2 - x_1^2 x_2 + \alpha x_1 y_1 \quad (438)$$

$$\frac{dy_1}{dt} = y_2 \quad (439)$$

$$\frac{dy_2}{dt} = -y_1 - y_2 + x_1^2 \quad (440)$$

Linearization in a neighborhood of the equilibrium point at the origin shows that at  $c = 0$  there is a center manifold tangent to the  $x_1$ - $x_2$  plane. However, restricting  $c$  to the value zero is undesirable here because we want to see the Hopf as  $c$  moves through zero. There is a standard trick for using the center manifold theorem for nonzero values of  $c$ , and it is based on the idea of treating the term  $cx_2$  as nonlinear, so it doesn't enter into the linearization at the origin. The trick is to consider  $c$  as another phase variable by appending the following equation to eqs.(437)-(440):

$$\frac{dc}{dt} = 0 \quad (441)$$

Now in the 5 dimensional  $x_1$ - $x_2$ - $y_1$ - $y_2$ - $c$  phase space, the center manifold is 3 dimensional and is tangent to the  $x_1$ - $x_2$ - $c$  hyperplane. We may obtain an approximation for the center manifold by expanding  $y_1$  and  $y_2$  in power series of  $x_1$ ,  $x_2$  and  $c$ . Keeping terms of quadratic order only, we write:

$$y_1 = a_1 x_1^2 + a_2 x_1 x_2 + a_3 x_1 c + a_4 x_2^2 + a_5 x_2 c + a_6 c^2 + \dots \quad (442)$$

$$y_2 = b_1 x_1^2 + b_2 x_1 x_2 + b_3 x_1 c + b_4 x_2^2 + b_5 x_2 c + b_6 c^2 + \dots \quad (443)$$

When we say that the center manifold is an invariant manifold, we mean that the vector field is tangent to it at all points. This means that the coefficients in eqs.(442),(443) must be chosen so as to satisfy the differential equations (437)-(441). The process may be outlined as follows:

1. Substitute the power series expressions for  $y_1$  and  $y_2$ , eqs.(442),(443), into the d.e.'s on  $dy_1/dt$  and  $dy_2/dt$ , eqs.(439) and (440).
2. The resulting equations will involve the derivatives  $dx_1/dt$  and  $dx_2/dt$ . Replace these derivatives by the d.e.'s on  $dx_1/dt$  and  $dx_2/dt$ , eqs.(437) and (438).
3. Since eq.(438) depends on  $y_1$ , the resulting equations will contain  $y_1$ . Replace  $y_1$  with the power series (442).
4. Now collect terms and set to zero the coefficients of the quadratic terms  $x_1^2, x_1x_2, x_1c, x_2^2, x_2c, c^2$  in both equations, giving a total of 12 linear simultaneous algebraic equations on the 12 coefficients  $a_i, b_i$  of eqs.(442),(443).
5. Solve these equations and substitute the result into the power series expressions for  $y_1$  and  $y_2$ , eqs.(442),(443), to obtain a quadratic approximation for the center manifold.

This process is computationally intensive and is best accomplished using computer algebra. The approximation can be extended to any order of truncation. Using this approach, we obtain the following approximate expression for the center manifold:

$$y_1 = \frac{8x_2^2}{13} - \frac{2x_1x_2}{13} + \frac{5x_1^2}{13} + \dots \tag{444}$$

$$y_2 = -\frac{2x_2^2}{13} - \frac{6x_1x_2}{13} + \frac{2x_1^2}{13} + \dots \tag{445}$$

The next step is to obtain the flow on the center manifold. Since the center manifold is tangent to the  $x_1$ - $x_2$ - $c$  hyperplane, we may use  $x_1$  and  $x_2$  as coordinates on the center manifold. The flow may therefore be obtained by substituting eq.(444) into eq.(438). This gives the equivalent one degree of freedom system:

$$\frac{d^2x}{dt^2} - c\frac{dx}{dt} + x + x^2\frac{dx}{dt} - \alpha x \left( \frac{8}{13} \left( \frac{dx}{dt} \right)^2 - \frac{2x}{13} \frac{dx}{dt} + \frac{5x^2}{13} \right) + \dots = 0 \tag{446}$$

Eq.(446) is of the form of eq.(435) with  $\beta_2 = -1 - \frac{2\alpha}{13}$  and  $\beta_4 = 0$ , giving the limit cycle amplitude from eq.(436):

$$A = \frac{2\sqrt{c}}{\sqrt{1 + \frac{2\alpha}{13}}} \tag{447}$$

Note that for  $\alpha = 0$ , eq.(447) recovers the uncoupled limit cycle amplitude of  $A = 2\sqrt{c}$ . Thus eq.(447) predicts the influence of the  $y$  oscillator on the limit cycle of the  $x$  oscillator. For example, for  $c = 0.01$  and  $\alpha = 5$ , eq.(447) gives  $A = 0.150$ , whereas the uncoupled limit cycle amplitude of the  $x$  oscillator for  $c = 0.01$  is  $A = 0.2$ . These values agree with numerical integrations of the original system (432),(433).

## 10.2 Problems

### Problem 10.1

Center Manifold Analysis. It is desired to make the equilibrium of the oscillator  $\frac{d^2x}{dt^2} + x = 0$  asymptotically stable by coupling it to a damped oscillator  $\frac{d^2z}{dt^2} + \frac{dz}{dt} + z = 0$  via the nonlinear coupling:

$$\frac{d^2x}{dt^2} + x = \frac{dx}{dt}z, \quad \frac{d^2z}{dt^2} + \frac{dz}{dt} + z = \gamma \left( \frac{dx}{dt} \right)^2 + x^2 \quad (448)$$

For some values of  $\gamma$  the origin  $x = \frac{dx}{dt} = z = \frac{dz}{dt} = 0$  is asymptotically stable, while for others it is unstable.

Find  $\gamma_c$ , the critical value of  $\gamma$  which separates asymptotic stability from instability.

Hint: Look for a center manifold in  $z$ - $\frac{dz}{dt}$ - $x$ - $\frac{dx}{dt}$  space which is tangent to the  $x$ - $\frac{dx}{dt}$  plane at the origin. Then use the two variable expansion method to study the flow on the center manifold.



## 11 N Coupled Limit Cycle Oscillators

There are numerous biological applications which involve a system of  $N$  coupled limit cycle oscillators. For example, swimming in lamprey consists of a sequence of traveling waves which pass down the body and propel the fish through the water. The muscular contractions which produce this movement are controlled by neural activity along the spinal cord. The spinal cord consists of about 100 individual segments, each of which is thought to be able to oscillate independently. This leads to a model of 100 coupled limit cycle oscillators, each of which may have a slightly different uncoupled frequency. The expected behavior involves frequency locked motion with phase differences between neighboring oscillators, corresponding to waves moving along the spinal cord.

Other biological examples include waves of peristalsis in the intestines, and waves of stomatal opening on the surface of a leaf.

How shall we model this kind of system of coupled oscillators? We cannot hope to derive the governing equations from basic principles of physics, since little may be known about the underlying mechanisms which produce the oscillation, including even the dimension of the phase space. On the other hand, it is reasonable to model such a biological oscillator as being structurally stable and exhibiting a unique attracting limit cycle. One way to proceed would be to choose a standard model of a limit cycle oscillator, such as a van der Pol oscillator, and to consider the dynamics of a coupled system of these. This would certainly produce a mathematically difficult problem.

An alternative approach is to model the individual limit cycle oscillator as being characterized only by its phase  $\theta_i$ . The limit cycle is pictured as a closed curve in an unknown phase space, coordinatized by its phase which we parameterize so that it runs uniformly in time from 0 to  $2\pi$  in each cycle. If  $\omega_i$  represents its frequency, then the individual oscillator may be modeled by the equation:

$$\frac{d\theta_i}{dt} = \omega_i \quad (449)$$

We shall refer to this model as a *phase-only oscillator*. A system of  $N$  coupled phase-only oscillators takes the form:

$$\frac{d\theta_i}{dt} = \omega_i + f_i(\theta_1, \dots, \theta_N) \quad (450)$$

where  $f_i$  models the effect of the other oscillators on  $\theta_i$ .

In this Chapter we will look at a one dimensional array of such oscillators with nearest-neighbor coupling.

### 11.1 Two Phase-Only Oscillators

To begin with, let us look at a system of two phase-only oscillators:

$$\frac{d\theta_1}{dt} = \omega_1 + f_1(\theta_1, \theta_2), \quad \frac{d\theta_2}{dt} = \omega_2 + f_2(\theta_1, \theta_2) \quad (451)$$

How shall we choose the coupling functions  $f_i$ ? We approach this by positing a series of assumptions:

1. We require that the coupling functions  $f_i$  be zero when both oscillators are at the same point in their cycles, that is, when  $\theta_1 = \theta_2$ . This assumption allows the oscillators to move in phase. This can be accomplished by requiring that  $f_i$  depends only on the difference between the phases, that is,  $f_i(\theta_1, \theta_2) = \alpha_i g(\theta_j - \theta_i)$  such that  $g(0) = 0$ . (Here  $\alpha_i$  is a coupling constant.)
2. We assume that the coupling functions depend only on the current values of  $\theta_1$  and  $\theta_2$ , and not upon how many cycles have already passed. This means that  $f_i$  should be a  $2\pi$ -periodic function of  $\theta_1$  and  $\theta_2$ , or in view of the previous assumption, that  $g$  should be a  $2\pi$ -periodic function of  $\theta_j - \theta_i$ .
3. We have now that  $g(\theta_j - \theta_i)$  should be a  $2\pi$ -periodic function for which  $g(0) = 0$ . We take the simplest choice,  $g(\theta_j - \theta_i) = \sin(\theta_j - \theta_i)$ .

With these assumptions, eqs.(451) become:

$$\frac{d\theta_1}{dt} = \omega_1 + \alpha_1 \sin(\theta_2 - \theta_1), \quad \frac{d\theta_2}{dt} = \omega_2 + \alpha_2 \sin(\theta_1 - \theta_2) \tag{452}$$

In order to study eqs.(452), we define a quantity  $\phi = \theta_1 - \theta_2$  which represents the phase lag of oscillator 2 relative to oscillator 1. Subtracting the second of (452) from the first, we obtain a d.e. on  $\phi$ :

$$\frac{d\phi}{dt} = \omega_1 - \omega_2 - (\alpha_1 + \alpha_2) \sin \phi \tag{453}$$

Like  $\theta_1$  and  $\theta_2$ ,  $\phi$  is defined on a circle. An equilibrium point of the circle flow (453) corresponds to a phase-locked motion of the system (452). Setting  $d\phi/dt = 0$  we obtain:

$$\sin \phi = \frac{\omega_1 - \omega_2}{\alpha_1 + \alpha_2} \tag{454}$$

Since  $|\sin \phi| \leq 1$ , the condition for real roots to eq.(454), and hence for phase-locked motions to eqs.(452), becomes:

$$\text{condition for phase locked motions: } \left| \frac{\omega_1 - \omega_2}{\alpha_1 + \alpha_2} \right| \leq 1 \tag{455}$$

Note that this condition is in qualitative agreement with the results found in Chapter 8 for two coupled van der Pol oscillators, namely that phase locking requires the difference in uncoupled frequencies to be small relative to the sum of the coupling constants. Substituting the expression for  $\sin \phi$  in (454) into eqs.(452), we obtain a value for the common locked frequency, which is a weighted average of the uncoupled frequencies  $\omega_1, \omega_2$ :

$$\frac{d\theta_1}{dt} = \frac{d\theta_2}{dt} = \frac{\alpha_1\omega_2 + \alpha_2\omega_1}{\alpha_1 + \alpha_2} \tag{456}$$

If condition (455) does not hold, the system undergoes *drift*, and the two oscillators operate at different average frequencies. The bifurcation which accompanies the transition between phase-lock and drift is a saddle-node. Of the two roots for  $\sin \phi$  given by eq.(454) in the phase-locked case, one is stable and one is unstable.

## 11.2 N Phase-Only Oscillators

In this section we generalize the system of two phase-only oscillators (452) by considering a line of  $N$  such oscillators with nearest neighbor coupling:

$$\frac{d\theta_1}{dt} = \omega_1 + \alpha \sin(\theta_2 - \theta_1) \quad (457)$$

$$\frac{d\theta_i}{dt} = \omega_i + \alpha (\sin(\theta_{i+1} - \theta_i) + \sin(\theta_{i-1} - \theta_i)), \quad i = 2, 3, \dots, N - 1 \quad (458)$$

$$\frac{d\theta_N}{dt} = \omega_N + \alpha \sin(\theta_{N-1} - \theta_N) \quad (459)$$

where we have taken all the coupling constants  $\alpha$  to be equal, but have allowed the frequencies  $\omega_i$  to be independent. Following the treatment of the 2 oscillator case, we set

$$\phi_i = \theta_i - \theta_{i+1}, \quad i = 1, 2, \dots, N - 1 \quad (460)$$

Using the variables  $\phi_i$ , eqs.(457)-(459) can be written in matrix form:

$$\frac{d\bar{\phi}}{dt} = \bar{\Omega} + \bar{A} \bar{S} \quad (461)$$

where  $\bar{\phi}$ ,  $\bar{\Omega}$  and  $\bar{S}$  are  $N - 1$  vectors:

$$\bar{\phi} = \begin{bmatrix} \phi_1 \\ \dots \\ \phi_{N-1} \end{bmatrix}, \quad \bar{\Omega} = \begin{bmatrix} \omega_1 - \omega_2 \\ \dots \\ \omega_{N-1} - \omega_N \end{bmatrix}, \quad \bar{S} = \begin{bmatrix} \sin \phi_1 \\ \dots \\ \sin \phi_{N-1} \end{bmatrix} \quad (462)$$

and where  $\bar{A}$  is a tri-diagonal  $N - 1 \times N - 1$  matrix:

$$\bar{A} = \alpha \begin{bmatrix} -2 & 1 & & & \\ 1 & -2 & 1 & & \\ & 1 & -2 & 1 & \\ & & & \dots & \\ & & & 1 & -2 \end{bmatrix} \quad (463)$$

As in the two oscillator case, equilibria of (463) correspond to phase locked motions of eqs.(457)-(459). Setting  $d\bar{\phi}/dt = 0$  we obtain:

$$\bar{S} = -\bar{A}^{-1} \bar{\Omega} \quad (464)$$

Note that in order for eq.(464) to have a real solution, each of the components of  $\bar{A}^{-1} \bar{\Omega}$  must not be larger than unity, since the components of  $\bar{S}$  are sines.

Now it turns out that the matrix  $\bar{A}$  in (463) can be inverted in closed form! The inverse  $\bar{A}^{-1}$  is a symmetric matrix, with elements:

$$\bar{A}_{ij}^{-1} = \frac{j(N-i)}{-N\alpha}, \quad (i \geq j) \quad (465)$$

where the elements for  $i < j$  are obtained from the symmetry of the matrix. For example when  $N = 6$ ,  $\bar{A}^{-1}$  is the  $5 \times 5$  matrix:

$$\bar{A}^{-1} = -\frac{1}{6\alpha} \begin{bmatrix} 5 & 4 & 3 & 2 & 1 \\ 4 & 8 & 6 & 4 & 2 \\ 3 & 6 & 9 & 6 & 3 \\ 2 & 4 & 6 & 8 & 4 \\ 1 & 2 & 3 & 4 & 5 \end{bmatrix} \quad (466)$$

As an example of the kind of calculation we can do with this model, suppose that the uncoupled frequencies  $\omega_i$  decreased uniformly along the chain of oscillators:

$$\omega_1 = \omega, \quad \omega_2 = \omega - \Delta, \quad \omega_3 = \omega - 2\Delta, \quad \omega_4 = \omega - 3\Delta, \quad \text{etc.} \quad (467)$$

Then the column vector  $\bar{\Omega}$  defined in eq.(462) becomes:

$$\bar{\Omega} = \begin{bmatrix} \omega_1 - \omega_2 \\ \omega_2 - \omega_3 \\ \dots \\ \omega_{N-1} - \omega_N \end{bmatrix} = \Delta \begin{bmatrix} 1 \\ 1 \\ \dots \\ 1 \end{bmatrix} \quad (468)$$

where  $\Delta$  is the uncoupled frequency difference between two adjacent oscillators. Using eqs.(464) and (465), the values of  $\phi_i$  for equilibrium are given by:

$$\sin \phi_i = \frac{\Delta i(N - i)}{\alpha 2}, \quad i = 1, \dots, N - 1 \quad (469)$$

For example, in the case of  $N = 6$  this gives (see eq.(466)):

$$\bar{S} = \begin{bmatrix} \sin \phi_1 \\ \sin \phi_2 \\ \sin \phi_3 \\ \sin \phi_4 \\ \sin \phi_5 \end{bmatrix} = \frac{\Delta}{2\alpha} \begin{bmatrix} 5 \\ 8 \\ 9 \\ 8 \\ 5 \end{bmatrix} \quad (470)$$

Requiring each of the sine terms to remain  $\leq 1$  gives the following condition for phase locking:

$$\left| \frac{\Delta}{\alpha} \right| \leq \frac{8}{N^2} \quad (471)$$

Note that once again the key quantity for phase locking is the ratio of frequency difference to coupling strength.

The models presented in this Chapter originally appeared in the paper “The Nature of the Coupling Between Segmental Oscillators of the Lamprey Spinal Generator for Locomotion: A Mathematical Model” by A.H.Cohen, P.J.Holmes and R.H.Rand, *J.Math.Biology* 13:345-369 (1982).

### 11.3 Problems

#### Problem 11.1

Plane array of coupled oscillators. In this problem you are to investigate the dynamics of a plane rectangular array of  $n^2$  identical phase-only oscillators with nearest neighbor coupling. We associate a phase  $\theta_{i,j}$  with an oscillator located at position  $(i, j)$  in the plane, where  $i, j = 1, 2, \dots, n$ . The d.e. governing a typical oscillator is:

$$\frac{d\theta_{i,j}}{dt} = \omega + \alpha [\sin(\theta_{i,j+1} - \theta_{i,j}) + \sin(\theta_{i,j-1} - \theta_{i,j}) + \sin(\theta_{i+1,j} - \theta_{i,j}) + \sin(\theta_{i-1,j} - \theta_{i,j})] \quad (472)$$

(Here we use the boundary convention that those sin terms which involve  $\theta_{i,j}$  for  $i, j = 0$  or  $N + 1$  are to be omitted.)

The problem is to simulate a system of up to 400 ( $n = 20$ ) such oscillators. For convenience take  $\omega = \alpha = 1$ . Since the oscillators are all identical, we might expect there to be a stable steady state in which all the oscillators have the same phase. However, there may be other stable steady states as well. The goal of this work is to investigate statistically how robust the in-phase steady state is, for random initial conditions, as a function of the number of oscillators.

Write a computer program which numerically integrates the d.e.'s (472) for random initial conditions. It should display the pattern which the square array of oscillators makes at a given time by using two colors, one for  $\sin \theta_{i,j} > 0$  and the other for  $\sin \theta_{i,j} < 0$ . The in-phase steady state will then show up as the entire field of oscillators being of the same color, and “blinking” in time.

On a given run, you should start the simulation and allow the transients to die out. Observe the steady state dynamics and classify it in words (for example, “in-phase, phase-locked motion”.)

Make a large number of runs for each of  $n = 5, 10, 15, 20$ . Count the number of runs which lead to each type of steady state which you have identified. Use your results to address the following question: Is the relative occurrence of the in-phase steady state a function of the number of oscillators?

#### Problem 11.2

In the treatment of  $N$  phase-only oscillators with uniformly decreasing uncoupled frequencies, eq.(467), suppose that the condition (471) for phase-locking is satisfied. Show that all  $N$  oscillators frequency-lock at a frequency equal to the average of their uncoupled frequencies.

#### Problem 11.3

Consider a line of  $N$  *identical* phase-only oscillators with nearest neighbor coupling, i.e. eqs.(457)-(459) with  $\omega_1 = \omega_2 = \dots = \omega_N$ . The equilibrium condition (469) becomes  $\sin \phi_i = 0$  for  $i=1, \dots, N-1$ . Each of these  $N-1$  equations has two possible solutions,  $\phi_i = 0$  and  $\phi_i = \pi$ . The system therefore has a total of  $2^{N-1}$  equilibrium points. Show that the only stable equilibrium is the “in-phase mode” for which  $\phi_1 = \phi_2 = \dots = \phi_{N-1} = 0$ .

## 12 Continuum of Coupled Conservative Oscillators

In the previous Chapters we have viewed an oscillator as a discrete entity. However, for some problems the most appropriate model is a continuum. Examples include the vibration of plates and shells and waves in fluids. Such models take the form of partial differential equations, in contrast to the o.d.e. models which we have studied so far.

In this Chapter we consider the nonlinear dynamics of a continuous line of conservative oscillators. We begin by deriving the governing equations of motion of a system of discrete particles restrained by nonlinear springs. Then we take the continuum limit and obtain a p.d.e. Finally, we investigate traveling wave solutions in the p.d.e.

### 12.1 Derivation

The system consists of a line of unit masses, each one coupled to its two nearest neighbors by nonlinear springs which have force-displacement characteristics  $F = \delta + \delta^2$ . When the springs are in unstretched equilibrium, the masses are a distance  $h$  apart. If  $u_i = u_i(t)$  represents the displacement of the  $i^{th}$  mass, the equations of motion become:

$$\frac{d^2 u_i}{dt^2} = [u_{i+1} - u_i + (u_{i+1} - u_i)^2] - [u_i - u_{i-1} + (u_i - u_{i-1})^2] \quad (473)$$

Now we wish to pass from the system of o.d.e.'s (473) to a p.d.e. via the continuum limit. We define a displacement field  $u = u(x, t)$  in which  $x$  plays the role that the subscript  $i$  plays in (473). The two schemes may be related by thinking of  $u_i(t)$  as corresponding to  $u(x_i, t)$ :

$$u_i(t) = u(x_i, t), \quad u_{i+1}(t) = u(x_{i+1}, t), \quad \text{where } x_{i+1} - x_i = h \quad (474)$$

Thus we may expand  $u_{i+1}$  in a Taylor series about  $x = x_i$ :

$$u_{i+1} = u(x_{i+1}, t) = u_i + \frac{\partial u}{\partial x} h + \frac{\partial^2 u}{\partial x^2} \frac{h^2}{2} + \frac{\partial^3 u}{\partial x^3} \frac{h^3}{6} + \frac{\partial^4 u}{\partial x^4} \frac{h^4}{24} + O(h^5) \quad (475)$$

where the partial derivatives are to be evaluated at  $x = x_i$ . Similarly we may expand  $u_{i-1}$  in a Taylor series about  $x = x_i$ :

$$u_{i-1} = u(x_{i-1}, t) = u_i - \frac{\partial u}{\partial x} h + \frac{\partial^2 u}{\partial x^2} \frac{h^2}{2} - \frac{\partial^3 u}{\partial x^3} \frac{h^3}{6} + \frac{\partial^4 u}{\partial x^4} \frac{h^4}{24} + O(h^5) \quad (476)$$

Now we substitute eqs.(475) and (476) into (474) and expand the algebra, giving the p.d.e.:

$$\frac{\partial^2 u}{\partial t^2} = h^2 \frac{\partial^2 u}{\partial x^2} + 2h^3 \frac{\partial u}{\partial x} \frac{\partial^2 u}{\partial x^2} + \frac{h^4}{12} \frac{\partial^4 u}{\partial x^4} + O(h^5) \quad (477)$$

Next we neglect terms of  $O(h^5)$  and define  $\tilde{x} = x/h$ , giving (dropping the tildes):

$$\frac{\partial^2 u}{\partial t^2} = \frac{\partial^2 u}{\partial x^2} + 2 \frac{\partial u}{\partial x} \frac{\partial^2 u}{\partial x^2} + \frac{1}{12} \frac{\partial^4 u}{\partial x^4} \quad (478)$$

Eq.(478) may be thought of as governing the longitudinal vibrations of a nonlinearly elastic rod.

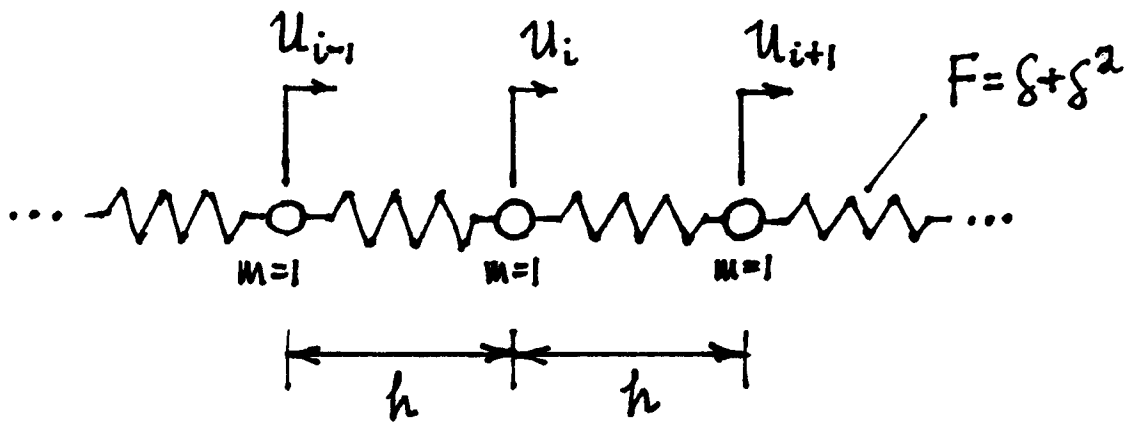

## 12.2 Traveling Wave Solution

In order to study any solutions of the p.d.e. (478) which represent traveling waves, that is, solutions whose shape does not change in a coordinate system which is uniformly translating along the  $x$  axis at speed  $c$ , we set  $u(x, t) = f(\xi)$ , where  $\xi = x - ct$ , giving the o.d.e.:

$$c^2 \frac{d^2 f}{d\xi^2} = \frac{d^2 f}{d\xi^2} + 2 \frac{df}{d\xi} \frac{d^2 f}{d\xi^2} + \frac{1}{12} \frac{d^4 f}{d\xi^4} \quad (479)$$

Defining  $v = \frac{df}{d\xi}$ , eq.(479) becomes:

$$c^2 \frac{dv}{d\xi} = \frac{dv}{d\xi} + 2 v \frac{dv}{d\xi} + \frac{1}{12} \frac{d^3 v}{d\xi^3} \quad (480)$$

Eq.(480) may be written in the form:

$$\frac{d}{d\xi} \left[ (1 - c^2)v + v^2 + \frac{1}{12} \frac{d^2 v}{d\xi^2} \right] = 0 \quad (481)$$

Eq.(481) may be integrated to give:

$$(1 - c^2)v + v^2 + \frac{1}{12} \frac{d^2 v}{d\xi^2} = k_1 \quad (482)$$

where  $k_1$  is a constant of integration. Multiplying eq.(482) by  $\frac{dv}{d\xi}$  and integrating gives:

$$\frac{d}{d\xi} \left[ (1 - c^2) \frac{v^2}{2} + \frac{v^3}{3} + \frac{1}{24} \left( \frac{dv}{d\xi} \right)^2 = k_1 v \right] \quad (483)$$

Introducing another constant of integration  $k_2$ , eq.(483) may be written in the form:

$$(1 - c^2) \frac{v^2}{2} + \frac{v^3}{3} + \frac{1}{24} \left( \frac{dv}{d\xi} \right)^2 = k_1 v + k_2 \quad (484)$$

So far we have not discussed boundary conditions. Now we impose the conditions that  $v$  and its derivatives vanish as  $\xi \rightarrow \pm\infty$ . From eqs.(482) and (484), this requires that  $k_1 = k_2 = 0$ , giving:

$$\frac{1}{24} \left( \frac{dv}{d\xi} \right)^2 = (c^2 - 1) \frac{v^2}{2} - \frac{v^3}{3} \quad (485)$$

Eq.(485) is separable and may be integrated to give the solution:

$$v(\xi) = \frac{\beta}{2 \cosh^2 \sqrt{\beta}(\xi - \xi_0)}, \quad \beta = 3(c^2 - 1) \quad (486)$$

where  $\xi_0$  is a constant of integration. Since  $v = \frac{df}{d\xi}$ , we may obtain an expression for  $f$  by integrating (486):

$$f(\xi) = \frac{\sqrt{\beta}}{2} \tanh \sqrt{\beta}(\xi - \xi_0) + f_0, \quad \beta = 3(c^2 - 1) \quad (487)$$



where  $f_0$  is a constant of integration. Finally, this may be written in terms of the original displacement field  $u(x, t)$ :

$$u(x, t) = \frac{\sqrt{\beta}}{2} \tanh \sqrt{\beta}(x - ct - \xi_0) + f_0, \quad \beta = 3(c^2 - 1) \quad (488)$$

Eq.(488) is an exact solution to the p.d.e. (478). It represents a family of traveling waves with wavespeed  $c \geq 1$  as parameter. Note that the wave's amplitude is dependent on its wavespeed, a typical nonlinear effect.

## 13 Melnikov's Method for Predicting Chaos

Melnikov's method is a procedure which gives a bound on the parameters of a system such that chaos is predicted not to occur. It is applicable to conservative one degree of freedom systems which include a separatrix loop, and which are perturbed by small forcing and damping.

The idea is to show by perturbation expansions that there exists an intersection of the stable and unstable manifolds of an equilibrium point in a two-dimensional Poincare map  $M$ . This implies that there is a horseshoe in the map  $M$ , which in turn implies that there exist periodic motions of all periods, as well as motions which are not periodic. The horseshoe map also exhibits sensitive dependence on initial conditions.

The method will be applied to a class of systems of the form:

$$\ddot{x} - x + N(x) = \epsilon g(x, \dot{x}, t) \quad (489)$$

where  $\epsilon$  is a small parameter, and where the perturbation  $g$  is of the form:

$$g(x, \dot{x}, t) = A \cos \omega t - B \dot{x} \quad (490)$$

where  $N(x)$  is a nonlinear function of  $x$  such that

- i)  $N(0) = 0$ , that is, the origin  $x = \dot{x} = 0$  in the  $\epsilon = 0$  system is an equilibrium point (a saddle), and
- ii) the  $\epsilon = 0$  system has a separatrix loop through the origin.

The separatrix loop in the  $\epsilon = 0$  system will generally be "broken" when the perturbation is applied. The question of whether or not chaos can occur in a particular system depends upon what happens to the broken pieces of the separatrix loop (the stable and unstable manifolds of the saddle), that is, whether they intersect or not.

In the case of eq.(489), Melnikov's method involves the following integral:

$$\Delta(\tau) = \int_{-\infty}^{\infty} \dot{x}_0 g(x_0, \dot{x}_0, t) dt \quad (491)$$

where  $(x_0(t), \dot{x}_0(t))$  is a solution on the separatrix loop in the  $\epsilon = 0$  system. This solution is chosen to satisfy an initial condition on the unperturbed separatrix loop at time  $t = \tau$ . Since the  $\epsilon = 0$  system is autonomous, this means that  $x_0$  and  $\dot{x}_0$  will be functions of  $t - \tau$ .

The function  $\Delta(\tau)$  characterizes the size of the gap between the stable and unstable manifolds of the saddle. If  $\Delta(\tau)$  vanishes for some  $\tau$ , then the stable and unstable manifolds intersect and (489) is predicted to contain a horseshoe. If  $\Delta(\tau)$  does not vanish for any  $\tau$ , then Melnikov's method predicts that there is no intersection of the stable and unstable manifolds, and hence no associated horseshoe or chaos in (489). All these results assume that  $\epsilon$  is a small quantity. For a derivation of eq.(491), see "Nonlinear Oscillations, Dynamical Systems, and Bifurcations of Vector Fields" by J.Guckenheimer and P.Holmes, Springer Verlag, 1983, pp.184-193.

### 13.1 Example

As an example, we take  $N(x) = -\frac{x^2}{2}$ , whereupon eq.(489) becomes:

$$\ddot{x} - x - \frac{x^2}{2} = \epsilon(A \cos \omega t - B\dot{x}) \tag{492}$$

Our task is to evaluate  $\Delta(\tau)$ , which from eq.(491) becomes:

$$\Delta(\tau) = \int_{-\infty}^{\infty} \dot{x}_0 (A \cos \omega t - B\dot{x}_0) dt \tag{493}$$

We begin by computing  $x_0$ . For  $\epsilon = 0$ , eq.(492) becomes:

$$\ddot{x} - x - \frac{x^2}{2} = 0 \tag{494}$$

Eq.(494) has equilibria at  $x = 0$  and  $x = -2$ . It has a first integral of the form:

$$\frac{\dot{x}^2}{2} - \frac{x^2}{2} - \frac{x^3}{6} = h = \text{constant} \tag{495}$$

The separatrix loop corresponds to the integral curve which passes through the origin, corresponding to  $h = 0$ :

$$\dot{x}^2 = x^2 + \frac{x^3}{3} \tag{496}$$

Note that the separatrix loop (496) intersects the  $x$ -axis at  $x = -3$  (as well as at the separatrix at  $x = 0$ ). We solve (496) by “separating variables” and integrating from  $t$  to  $\tau$ :

$$\int \frac{dx}{\sqrt{x^2 + \frac{x^3}{3}}} = \pm \int dt \implies -2 \operatorname{arctanh} \sqrt{1 + \frac{x}{3}} \Big|_{x(t)}^{x(\tau)} = \pm(t - \tau) \tag{497}$$

Here  $x(\tau)$  corresponds to an arbitrary point on the separatrix loop. We choose  $x(\tau) = -3$  without loss of generality. Then solving (497) for  $x(t)$  gives:

$$x(t) = x_0(t) = 3 \left( \tanh^2\left(\frac{t - \tau}{2}\right) - 1 \right) = \frac{-3}{\cosh^2\left(\frac{t - \tau}{2}\right)} \tag{498}$$

Differentiating (498) gives an expression for  $\dot{x}_0$  along the separatrix loop, which we need in order to evaluate the Melnikov integral (493):

$$\dot{x}_0(t) = 3 \frac{\sinh\left(\frac{t - \tau}{2}\right)}{\cosh^3\left(\frac{t - \tau}{2}\right)} \tag{499}$$

Substituting (499) into (493), setting  $z = t - \tau$  and using the trig identity

$$\cos \omega t = \cos \omega(z + \tau) = \cos \omega z \cos \omega \tau - \sin \omega z \sin \omega \tau \tag{500}$$

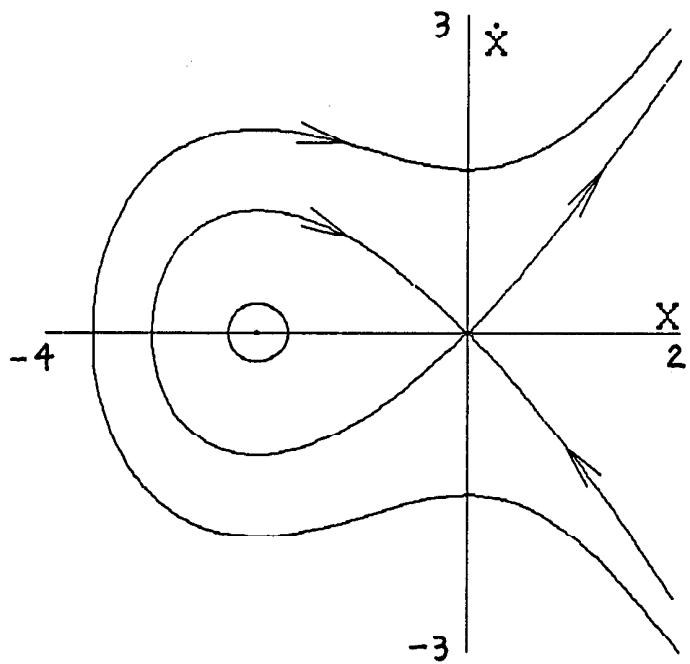

Phase plane for  $\ddot{x} - x - \frac{x^2}{2} = 0$ .

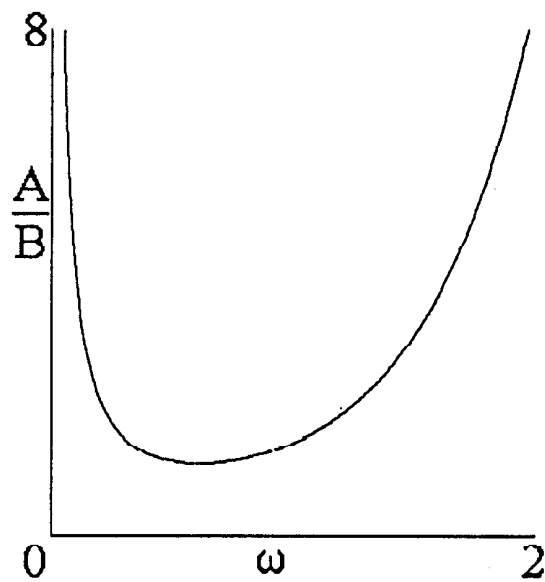

The result of Melnikov's method: Horseshoes are predicted to occur for parameters  $A$ ,  $B$  and  $\omega$  which lie above the curve.

gives

$$\Delta(\tau) = \int_{-\infty}^{\infty} 3 \frac{\sinh z/2}{\cosh^3 z/2} \left( A(\cos \omega z \cos \omega \tau - \sin \omega z \sin \omega \tau) - 3B \frac{\sinh z/2}{\cosh^3 z/2} \right) dz \quad (501)$$

Note that the term  $\frac{\sinh z/2}{\cosh^3 z/2} \cos \omega z$  integrates to zero since it is an odd function of  $z$ . Rearranging (501) gives

$$\Delta(\tau) = -3(AI_1 \sin \omega \tau + 3BI_2) \quad (502)$$

where

$$I_1 = \int_{-\infty}^{\infty} \frac{\sinh z/2}{\cosh^3 z/2} \sin \omega z \, dz \quad \text{and} \quad I_2 = \int_{-\infty}^{\infty} \frac{\sinh^2 z/2}{\cosh^6 z/2} \, dz \quad (503)$$

It remains to evaluate the integrals  $I_1$  and  $I_2$ . It turns out that  $I_2$  can be evaluated as an indefinite integral, but  $I_1$  requires contour integration and the method of residues. Details can be found in “Topics in Nonlinear Dynamics with Computer Algebra” by R.H.Rand, Gordon and Breach, 1994, pp.179-182. The results are:

$$I_1 = \frac{4\pi\omega^2}{\sinh \pi\omega} \quad \text{and} \quad I_2 = \frac{8}{15} \quad (504)$$

Using these values in eq.(502) gives

$$\Delta(\tau) = -3 \left( A \sin \omega \tau \frac{4\pi\omega^2}{\sinh \pi\omega} + 3B \frac{8}{15} \right) \quad (505)$$

For an intersection of the stable and unstable manifolds, we set  $\Delta(\tau) = 0$  and seek a (real) value for  $\tau$ . Eq.(505) gives

$$\sin \omega \tau = -\frac{2B \sinh \pi\omega}{5A\pi\omega^2} \quad (506)$$

For a real solution  $\tau$ ,  $|\sin \omega \tau| \leq 1$ . From (506) this requires that the ratio of the forcing amplitude  $A$  to the damping coefficient  $B$  (see eq.(492)) be larger than the critical ratio:

$$\left( \frac{A}{B} \right)_{cr} = \frac{2 \sinh \pi\omega}{5\pi\omega^2} \quad (507)$$

If  $A/B$  is larger than  $(A/B)_{cr}$  then Melnikov’s method predicts that the Poincare map associated with eq.(492) will contain a horseshoe. Note: this Poincare map is generated by the cut  $t = 0 \pmod{2\pi/\omega}$ . This prediction is limited to small values of  $\epsilon$ .

It is important to remember that the existence of a horseshoe does not imply the existence of a chaotic attractor. Although the horseshoe itself is chaotic, its presence may show up as transient chaos if it coexists with a periodic attractor. Numerical and experimental approaches to chaos have shown that the Melnikov criterion generally represents a lower bound on chaos. For example in eq.(492), for a given value of  $\omega$ , if  $A/B$  is smaller than the critical value (507), then we see no chaos. For values of  $A/B$  which are greater than  $(A/B)_{cr}$ , we see either transient chaos or escape to infinity.

## 13.2 Problems

**Problem 13.1** Use Melnikov's method to find the critical ratio  $(A/B)_{cr}$  for the system:

$$\ddot{x} - x + x^3 = \epsilon(A \cos \omega t - B\dot{x}) \quad (508)$$

Answer:  $\frac{2\sqrt{2}}{3\pi\omega} \cosh \frac{\pi\omega}{2}$

**Problem 13.2** Use Melnikov's method to find the critical ratio  $(A/B)_{cr}$  for the system:

$$\ddot{x} - \sin x = \epsilon(A \cos \omega t - B\dot{x}) \quad (509)$$

Answer:  $\frac{4}{\pi} \cosh \frac{\pi\omega}{2}$

## 14 Differential-Delay Equations

Some dynamical processes are modeled as differential-delay equations (abbreviated DDE). An example is

$$\frac{dx(t)}{dt} = -x(t - T) - x(t)^3 \quad (510)$$

Here the rate of growth of  $x$  at time  $t$  is related both to the value of  $x$  at time  $t$ , and also to the value of  $x$  at a previous time,  $t - T$ .

Applications of DDE include laser dynamics, where the source of the delay is the time it takes light to travel from one point to another; machine tool vibrations, where the delay is due to the dependence of the cutting force on thickness of the rotating workpiece; gene dynamics, where the delay is due to the time required for messenger RNA to copy the genetic code and export it from the nucleus to the cytoplasm; investment analysis, where the delay is due to the time required by bookkeepers to determine the current state of the system; and physiological dynamics, where the delay comes from the time it takes a substance to travel via the bloodstream from one organ to another.

A generalized version of eq.(510) is

$$\frac{dx(t)}{dt} = \alpha x(t) + \beta x(t - T) + f(x(t), x(t - T)) \quad (511)$$

where  $\alpha$  and  $\beta$  are coefficients and  $f$  is a strictly nonlinear function of  $x(t)$  and  $x(t - T)$ . Here the linear terms  $\alpha x(t)$  and  $\beta x(t - T)$  have been separated from the strictly nonlinear terms, a step which facilitates stability analysis.

### 14.1 Stability of Equilibrium

Eq.(511) has the trivial equilibrium solution  $x(t) = 0$ . Is it stable? In order to find out, we linearize eq.(511) about  $x = 0$ :

$$\frac{dx(t)}{dt} = \alpha x(t) + \beta x(t - T) \quad (512)$$

Since eq.(512) has constant coefficients, we look for a solution in the form  $x = e^{\lambda t}$ , which gives the characteristic equation:

$$\lambda = \alpha + \beta e^{-\lambda T} \quad (513)$$

Eq.(513) is a transcendental equation and will in general have an infinite number of roots, which will either be real or will occur in complex conjugate pairs. The equilibrium  $x = 0$  will be stable if all the real parts of the roots are negative, and unstable if any root has a positive real part. In the intermediate case in which no roots have positive real part, but some roots have zero real part, the linear stability analysis is inadequate, and nonlinear terms must be considered.

As an example, we consider eq.(510), for which eq.(513) becomes

$$\lambda = -e^{-\lambda T} \quad (514)$$

Since  $\lambda$  will be complex in general, we set  $\lambda = \mu + i\omega$ , where  $\mu$  and  $\omega$  are the real and imaginary parts. Substitution into eq.(514) gives two real equations:

$$\mu = -e^{-\mu T} \cos \omega T \tag{515}$$

$$\omega = e^{-\mu T} \sin \omega T \tag{516}$$

The question of stability will depend upon the value of the delay parameter  $T$ . Certainly when  $T = 0$  the system is stable. By continuity, as  $T$  is increased from zero, there will come a first positive value of  $T$  for which  $x = 0$  is not (linearly) stable. This can happen in one of two ways. Either a single real root will pass through the origin in the complex- $\lambda$  plane, or a pair of complex conjugate roots will cross the imaginary axis. Since  $\mu=\omega=0$  does not satisfy eqs.(515),(516), the first case cannot occur.

In order to consider the second case of a purely imaginary pair of roots, we set  $\mu = 0$  in eqs.(515),(516), giving

$$0 = -\cos \omega T \tag{517}$$

$$\omega = \sin \omega T \tag{518}$$

Eq.(517) gives  $\omega T = \pi/2$ , whereupon eq.(518) gives  $\omega = 1$ , from which we conclude that the critical value of delay  $T = T_{cr} = \pi/2$ . That is,  **$\mathbf{x} = \mathbf{0}$  in eq.(510) is stable for  $\mathbf{T} < \pi/2$  and is unstable for  $\mathbf{T} > \pi/2$** . Stability for  $T = T_{cr} = \pi/2$  requires consideration of nonlinear terms.

In order to check these results we numerically integrate eq.(510). Note that this requires that the values of  $x$  be given on the entire interval  $-T \leq t \leq 0$ . The Figure shows the results of numerical integration using the initial condition  $x = 0.01$  on  $-T \leq t \leq 0$ . The upper plot is for  $T = \pi/2 - 0.01$  and shows stability, while the lower plot is for  $T = \pi/2 + 0.01$  and shows instability, in agreement with the foregoing analysis.

## 14.2 Lindstedt's Method

The change in stability observed in the preceding example will be accompanied by the birth of a limit cycle in a Hopf bifurcation. In order to obtain an approximation for the amplitude and frequency of the resulting periodic motion, we use Lindstedt's method.

We begin by stretching time,

$$\tau = \omega t \tag{519}$$

Replacing  $t$  by  $\tau$  as independent variable, eq.(510) may be written in the form:

$$\omega \frac{dx(\tau)}{d\tau} = -x(\tau - \omega T) - x(\tau)^3 \tag{520}$$

Next we choose the delay  $T$  to be close to the critical value  $T_{cr} = \pi/2$ :

$$T = \frac{\pi}{2} + \Delta \tag{521}$$



$dx/dt = -x(t-T) - x^3$  for  $T = \pi/2 - 0.01$  with i.c.  $x = 0.01$  on  $[-T, 0]$

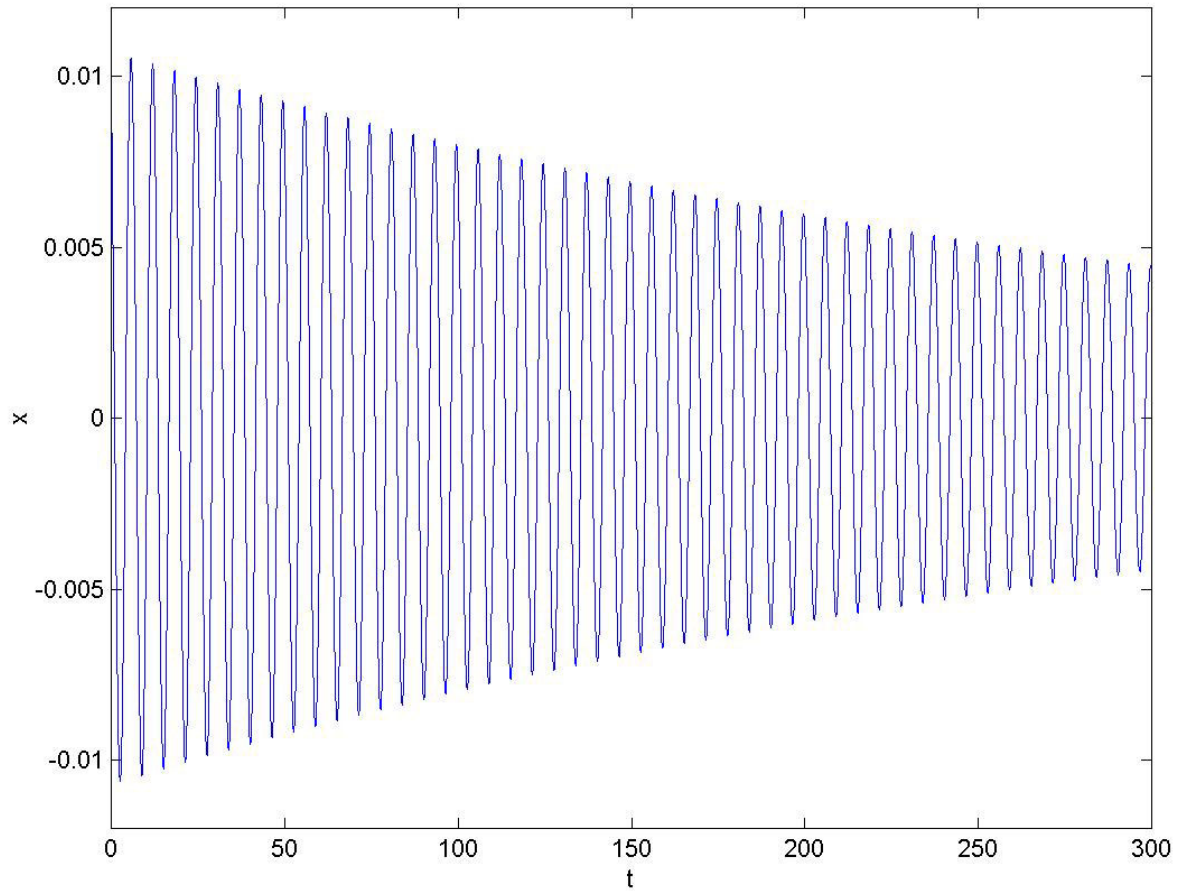

$dx/dt = -x(t-T) - x^3$  for  $T = \pi/2 + 0.01$  with i.c.  $x = 0.01$  on  $[-T, 0]$

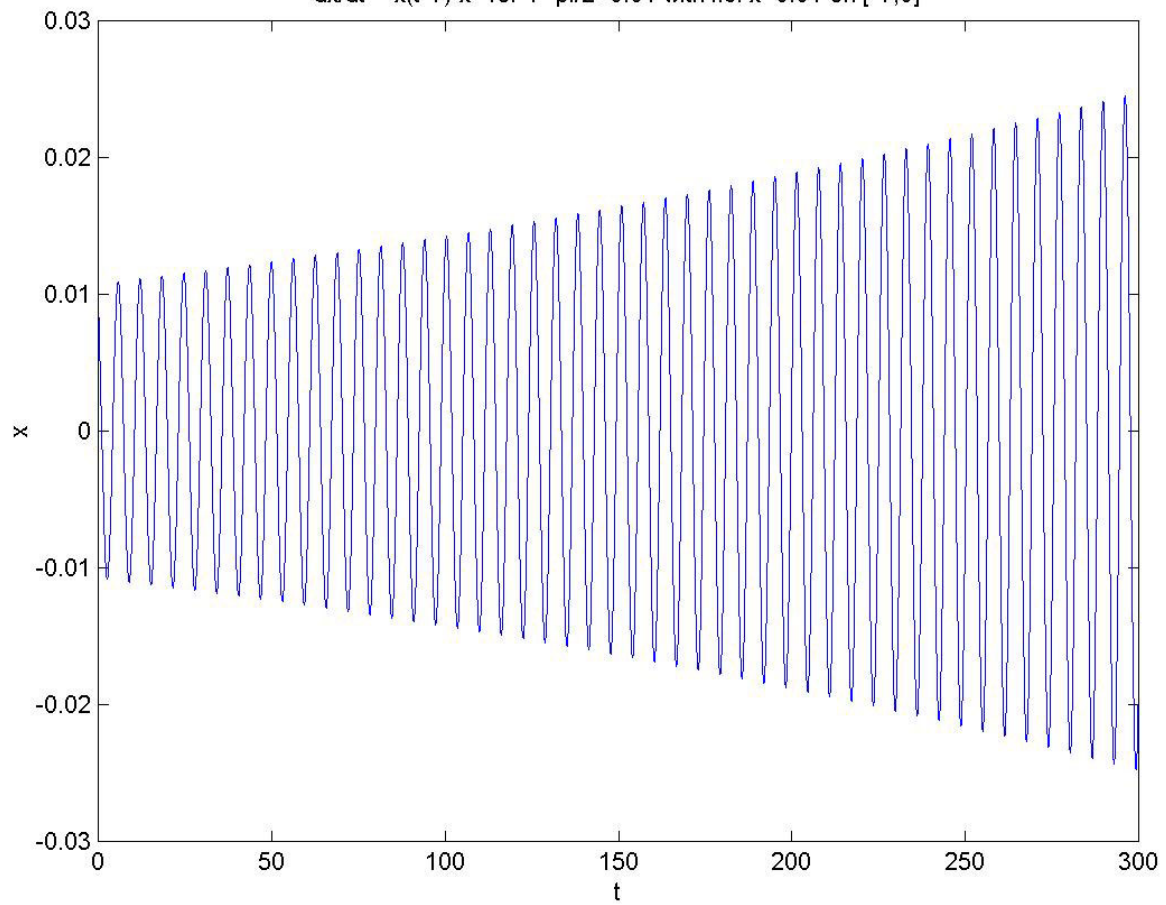

We introduce a perturbation parameter  $\epsilon \ll 1$  by scaling  $x$ :

$$x = \sqrt{\epsilon}u \tag{522}$$

Using eq.(522), eq.(520) becomes:

$$\omega \frac{du(\tau)}{d\tau} = -u(\tau - \omega T) - \epsilon u(\tau)^3 \tag{523}$$

Next we scale  $\Delta$

$$\Delta = \epsilon\mu \tag{524}$$

and we expand  $u$  and  $\omega$  in power series of  $\epsilon$ :

$$u(\tau) = u_0(\tau) + \epsilon u_1(\tau) + O(\epsilon^2) \tag{525}$$

$$\omega = 1 + \epsilon k_1 + O(\epsilon^2) \tag{526}$$

where we have used the fact that  $\omega=1$  when  $T=T_{cr}$ .

The delay term  $u(\tau - \omega T)$  is handled by expanding it in Taylor series about  $\epsilon=0$ :

$$u(\tau - \omega T) = u\left(\tau - (1 + \epsilon k_1 + O(\epsilon^2))\left(\frac{\pi}{2} + \epsilon\mu\right)\right) \tag{527}$$

$$= u\left(\tau - \frac{\pi}{2} - \epsilon\left(k_1\frac{\pi}{2} + \mu\right) + O(\epsilon^2)\right) \tag{528}$$

$$= u\left(\tau - \frac{\pi}{2}\right) - \epsilon\left(k_1\frac{\pi}{2} + \mu\right)\frac{du}{d\tau}\left(\tau - \frac{\pi}{2}\right) + O(\epsilon^2) \tag{529}$$

Substituting into eq.(523) and collecting terms gives:

$$\epsilon^0 : \quad \frac{du_0}{d\tau} + u_0\left(\tau - \frac{\pi}{2}\right) = 0 \tag{530}$$

$$\epsilon^1 : \quad \frac{du_1}{d\tau} + u_1\left(\tau - \frac{\pi}{2}\right) = -k_1\frac{du_0}{d\tau} + \left(k_1\frac{\pi}{2} + \mu\right)\frac{du_0}{d\tau}\left(\tau - \frac{\pi}{2}\right) - u_0^3 \tag{531}$$

Since eq.(510) is autonomous, we may choose the phase of the periodic motion arbitrarily. This permits us to take the solution to eq.(530) as:

$$u_0(\tau) = A \cos \tau \tag{532}$$

where  $A$  is the approximate amplitude of the periodic motion. Substituting eq.(532) into (531), we obtain:

$$\frac{du_1}{d\tau} + u_1\left(\tau - \frac{\pi}{2}\right) = k_1 A \sin \tau + \left(k_1\frac{\pi}{2} + \mu\right)A \cos \tau - A^3 \left(\frac{3}{4} \cos \tau + \frac{1}{4} \cos 3\tau\right) \tag{533}$$

For no secular terms, we equate to zero the coefficients of  $\sin \tau$  and  $\cos \tau$  on the RHS of eq.(533). This gives:

$$k_1 = 0 \quad \text{and} \quad A = \frac{2}{\sqrt{3}}\sqrt{\mu} \tag{534}$$

Now  $A$  is the amplitude in  $u$ . In order to obtain the amplitude in  $x$ , we multiply the second of eqs.(534) by  $\sqrt{\epsilon}$ , which, together with eqs.(522) and (524), gives

$$\text{Amplitude of periodic motion in eq.(510)} = \frac{2}{\sqrt{3}}\sqrt{\Delta} = \frac{2}{\sqrt{3}}\sqrt{\left(T - \frac{\pi}{2}\right)} \tag{535}$$

This predicts, for example, that when  $T = \pi/2 + 0.01$ , the limit cycle born in the Hopf will have approximate amplitude of 0.1155. For comparison, numerical integration gives a value of 0.1145, see Figure.

### 14.3 Center Manifold Analysis

In order to determine the stability of the  $x=0$  solution of a DDE in the form of eq.(511),

$$\frac{dx(t)}{dt} = \alpha x(t) + \beta x(t - T) + f(x(t), x(t - T)) \tag{536}$$

in the case that the delay  $T$  takes on its critical value  $T_{cr}$ , it is necessary to take into account the effect of nonlinear terms. This may be accomplished by using a center manifold reduction. In order to accomplish this, the DDE is reformulated as an evolution equation on a function space. Our treatment closely follows that presented in Kalmar-Nagy, Stepan and Moon, *Nonlinear Dynamics* 26:121-142 (2001).

The idea here is that the initial condition for eq.(536) consists of a function defined on  $-T \leq t \leq 0$ . As  $t$  increases from zero we may consider the piece of the solution lying in the time interval  $[-T + t, t]$  as having evolved from the initial condition function. In order to avoid confusion, the variable  $\theta$  is used to identify a point in the interval  $[-T, 0]$ , whereupon  $x(t + \theta)$  will represent the piece of the solution which has evolved from the initial condition function at time  $t$ . From the point of view of the function space,  $t$  is a parameter, and it is  $\theta$  which is the independent variable. To emphasize this, we write:

$$x_t(\theta) = x(t + \theta) \tag{537}$$

The evolution equation, which acts on a function space consisting of continuously differentiable functions on  $[-T, 0]$ , is written:

$$\frac{\partial x_t(\theta)}{\partial t} = \begin{cases} \frac{\partial x_t(\theta)}{\partial \theta} & \text{for } \theta \in [-T, 0) \\ \alpha x_t(0) + \beta x_t(-T) + f(x_t(0), x_t(-T)) & \text{for } \theta = 0 \end{cases} \tag{538}$$

Here the DDE (536) appears as a boundary condition at  $\theta = 0$ . The rest of the interval goes along for the ride, which is to say that the equation  $\frac{\partial x_t(\theta)}{\partial t} = \frac{\partial x_t(\theta)}{\partial \theta}$  is an identity due to eq.(537).

$dx/dt = -x(t-T) - x^3$  for  $T = \pi/2 + 0.01$  with i.c.  $x = 0.05$  on  $[-T, 0]$

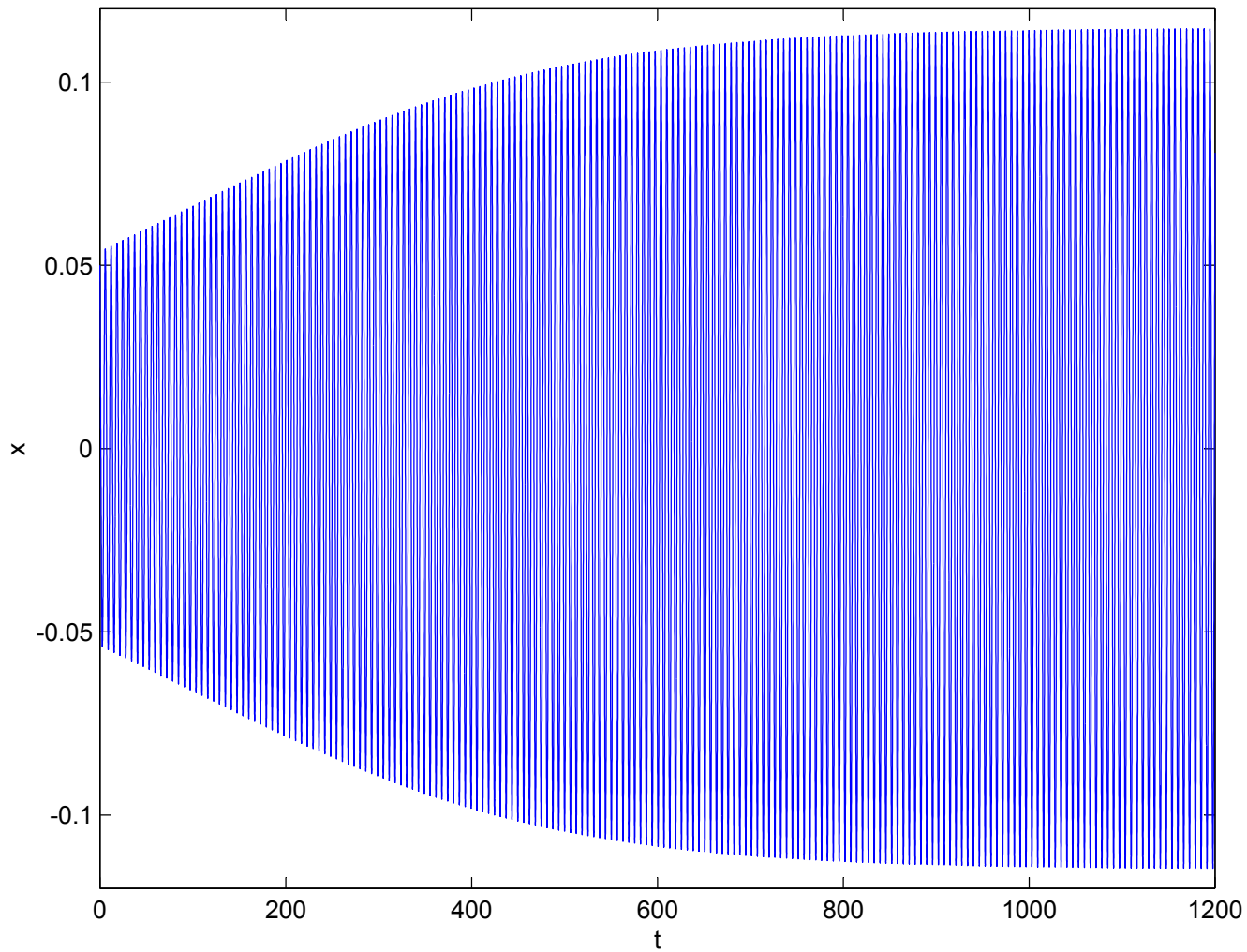

The RHS of eq.(538) may be written as the sum of a linear operator  $A$  and a nonlinear operator  $F$ :

$$Ax_t(\theta) = \begin{cases} \frac{\partial x_t(\theta)}{\partial \theta} & \text{for } \theta \in [-T, 0) \\ \alpha x_t(0) + \beta x_t(-T) & \text{for } \theta = 0 \end{cases} \quad (539)$$

$$Fx_t(\theta) = \begin{cases} 0 & \text{for } \theta \in [-T, 0) \\ f(x_t(0), x_t(-T)) & \text{for } \theta = 0 \end{cases} \quad (540)$$

We now assume that the delay  $T$  is set at its critical value for a Hopf bifurcation, i.e. the characteristic equation has a pair of pure imaginary roots,  $\lambda = \pm\omega i$ . Corresponding to these eigenvalues are a pair of eigenfunctions  $s_1(\theta)$  and  $s_2(\theta)$  which satisfy the eigenequation:

$$A(s_1(\theta) + is_2(\theta)) = i\omega(s_1(\theta) + is_2(\theta)) \quad (541)$$

That is,

$$As_1(\theta) = -\omega s_2(\theta) \quad (542)$$

$$As_2(\theta) = \omega s_1(\theta) \quad (543)$$

From the definition (539) of the linear operator  $A$  we find that  $s_1(\theta)$  and  $s_2(\theta)$  must satisfy the following differential equations and boundary conditions:

$$\frac{d}{d\theta}s_1(\theta) = -\omega s_2(\theta) \quad (544)$$

$$\frac{d}{d\theta}s_2(\theta) = \omega s_1(\theta) \quad (545)$$

$$\alpha s_1(0) + \beta s_1(-T) = -\omega s_2(0) \quad (546)$$

$$\alpha s_2(0) + \beta s_2(-T) = \omega s_1(0) \quad (547)$$

Let's illustrate this process by using eq.(510) as an example. We saw earlier that at  $T=T_{cr}=\pi/2$ ,  $\omega=1$ , which permits us to solve eqs.(544)-(545) as:

$$s_1(\theta) = c_1 \cos \theta - c_2 \sin \theta \quad (548)$$

$$s_2(\theta) = c_1 \sin \theta + c_2 \cos \theta \quad (549)$$

where  $c_1$  and  $c_2$  are arbitrary constants. In the case of eq.(510), the boundary conditions (546)-(547) become ( $\alpha=0, \beta=-1$ ):

$$-s_1(-\pi/2) = -s_2(0) \quad (550)$$

$$-s_2(-\pi/2) = s_1(0) \quad (551)$$

Eqs.(548)-(549) identically satisfy eqs.(550)-(551) so that the constants of integration  $c_1$  and  $c_2$  remain arbitrary at this point.

In preparation for the center manifold analysis, we write the solution  $x_t(\theta)$  as a sum of points lying in the center subspace (spanned by  $s_1(\theta)$  and  $s_2(\theta)$ ) and of points which do not lie in the center subspace, i.e., the rest of the solution, here called  $w$ :

$$x_t(\theta) = y_1(t)s_1(\theta) + y_2(t)s_2(\theta) + w(t)(\theta) \tag{552}$$

Here  $y_1(t)$  and  $y_2(t)$  are the components of  $x_t(\theta)$  lying in the directions  $s_1(\theta)$  and  $s_2(\theta)$  respectively.

**The idea of the center manifold reduction is to find  $w$  as an approximate function of  $y_1$  and  $y_2$  (the center manifold), and then to substitute  $w(y_1, y_2)$  into the equations on  $y_1(t)$  and  $y_2(t)$ . The result is that we will have replaced the original infinite dimensional system with a two dimensional approximation.**

In order to find the equations on  $y_1(t)$  and  $y_2(t)$ , we need to project  $x_t(\theta)$  onto the center subspace. In this system, projections are accomplished by means of a bilinear form:

$$(v, u) = v(0)u(0) + \int_{-T}^0 v(\theta + T)\beta u(\theta)d\theta \tag{553}$$

where  $u(\theta)$  lies in the original function space, i.e. the space of continuously differentiable functions defined on  $[-T, 0]$ , and where  $v(\theta)$  lies in the adjoint function space of continuously differentiable functions defined on  $[0, T]$ .

In order to project  $x_t(\theta)$  onto the center subspace, we will need the adjoint eigenfunctions  $n_1(\theta)$  and  $n_2(\theta)$  which satisfy the adjoint eigenequation:

$$A(n_1(\theta) + in_2(\theta)) = -i\omega(n_1(\theta) + in_2(\theta)) \tag{554}$$

That is,

$$A^*n_1(\theta) = \omega n_2(\theta) \tag{555}$$

$$A^*n_2(\theta) = -\omega n_1(\theta) \tag{556}$$

where the adjoint operator  $A^*$  is defined by

$$A^*v(\theta) = \begin{cases} -\frac{dv(\theta)}{d\theta} & \text{for } \theta \in (0, T] \\ \alpha v(0) + \beta v(T) & \text{for } \theta = 0 \end{cases} \tag{557}$$

In addition, the adjoint eigenfunctions  $n_i$  are defined to be orthonormal to the eigenfunctions  $s_i$ :

$$(n_i, s_j) = \begin{cases} 1 & \text{if } i = j \\ 0 & \text{if } i \neq j \end{cases} \tag{558}$$

From the definition (557) of the linear operator  $A^*$  we find that  $n_1(\theta)$  and  $n_2(\theta)$  must satisfy the following differential equations and boundary conditions:

$$-\frac{d}{d\theta}n_1(\theta) = \omega n_2(\theta) \tag{559}$$

$$-\frac{d}{d\theta}n_2(\theta) = -\omega n_1(\theta) \tag{560}$$

$$\alpha n_1(0) + \beta n_1(T) = \omega n_2(0) \tag{561}$$

$$\alpha n_2(0) + \beta n_2(T) = -\omega n_1(0) \tag{562}$$

We continue to illustrate by using eq.(510) as an example. With  $\omega = 1$ , eqs.(559)-(560) may be solved as:

$$n_1(\theta) = d_1 \cos \theta - d_2 \sin \theta \tag{563}$$

$$n_2(\theta) = d_1 \sin \theta + d_2 \cos \theta \tag{564}$$

where  $d_1$  and  $d_2$  are arbitrary constants. In the case of eq.(510), the boundary conditions (561)-(562) become ( $\alpha=0, \beta=-1$ ):

$$-n_1(\pi/2) = n_2(0) \tag{565}$$

$$-n_2(\pi/2) = -n_1(0) \tag{566}$$

As in the case of the  $s_i$  eigenfunctions, eqs.(563)-(564) identically satisfy eqs.(565)-(566) so that the constants of integration  $d_1$  and  $d_2$  remain arbitrary.

The four arbitrary constants  $c_1, c_2, d_1, d_2$  of eqs.(548),(549),(563),(564) will be related by the orthonormality conditions (558). Let's illustrate this by computing  $(n_1, s_1)$  for the example of eq.(510). Using the definition of the bilinear form (553), we obtain:

$$(n_1, s_1) = n_1(0)s_1(0) + \int_{-\pi/2}^0 n_1 \left( \theta + \frac{\pi}{2} \right) (-1)s_1(\theta)d\theta \tag{567}$$

$$(n_1, s_1) = \frac{(2c_2 + \pi c_1) d_2 + (2c_1 - \pi c_2) d_1}{4} = 1 \tag{568}$$

Similarly, we find:

$$(n_1, s_2) = \frac{(\pi c_2 - 2c_1) d_2 + (2c_2 + \pi c_1) d_1}{4} = 0 \tag{569}$$

The other two orthonormality conditions give no new information since it turns out that  $(n_2, s_1) = -(n_1, s_2)$  and  $(n_2, s_2) = (n_1, s_1)$ . Thus eqs.(568) and (569) are 2 equations in 4 unknowns,  $c_1, c_2, d_1, d_2$ . Without loss of generality we take  $d_1 = 1$  and  $d_2 = 0$ , giving  $c_1 = \frac{8}{\pi^2+4}, c_2 = -\frac{4\pi}{\pi^2+4}$ . Thus the eigenfunctions  $s_i$  and  $n_i$  for eq.(510) become:

$$s_1(\theta) = \frac{4\pi \sin \theta + 8 \cos \theta}{\pi^2 + 4} \tag{570}$$

$$s_2(\theta) = \frac{8 \sin \theta - 4\pi \cos \theta}{\pi^2 + 4} \tag{571}$$

$$n_1(\theta) = \cos \theta \tag{572}$$

$$n_2(\theta) = \sin \theta \tag{573}$$

Recall that our purpose in solving for  $n_1$  and  $n_2$  was to obtain equations on  $y_1(t)$  and  $y_2(t)$ , the components of  $x_t(\theta)$  lying in the directions  $s_1(\theta)$  and  $s_2(\theta)$  respectively, see eq.(552). We have:

$$y_1(t) = (n_1, x_t), \quad y_2(t) = (n_2, x_t) \tag{574}$$

Differentiating (574) with respect to  $t$ :

$$\dot{y}_1(t) = (n_1, \dot{x}_t), \quad \dot{y}_2(t) = (n_2, \dot{x}_t) \tag{575}$$

Let us consider the first of these:

$$\dot{y}_1(t) = (n_1, \dot{x}_t) = (n_1, Ax_t + Fx_t) = (n_1, Ax_t) + (n_1, Fx_t) \tag{576}$$

Now by definition of the adjoint operator  $A^*$ ,

$$(n_1, Ax_t) = (A^*n_1, x_t) = (\omega n_2, x_t) = \omega(n_2, x_t) = \omega y_2 \tag{577}$$

So we have

and similarly

$$\begin{aligned} \dot{y}_1 &= \omega y_2 + (n_1, Fx_t) \\ \dot{y}_2 &= -\omega y_1 + (n_2, Fx_t) \end{aligned}$$

(578)

In eqs.(579), the quantities  $(n_i, Fx_t)$  are given by (cf. eq.(553)):

$$(n_i, Fx_t) = n_i(0)Fx_t(0) + \int_{-T}^0 n_i(\theta + T)\beta Fx_t(\theta)d\theta \tag{579}$$

$$= n_i(0)f(x_t)(0) \quad \text{since } Fx_t(\theta)=0 \text{ unless } \theta=0 \tag{580}$$

in which  $x_t = y_1(t)s_1(0)+y_2(t)s_2(0)+w(t)(0)$ . Continuing with the example of eq.(510), eqs.(579) become, using  $f = -x(t)^3$ :

$$\dot{y}_1 = y_2 - \left( \frac{8y_1}{\pi^2+4} - \frac{4\pi y_2}{\pi^2+4} + w(\theta=0) \right)^3 \quad \text{and} \quad \dot{y}_2 = -y_1 \tag{581}$$

where we have used  $s_1(0)=\frac{8}{\pi^2+4}$ ,  $s_2(0)=\frac{-4\pi}{\pi^2+4}$ ,  $n_1(0)=1$  and  $n_2(0)=0$  from eqs.(570)-(573).

The next step is to look for an approximate expression for the center manifold, which is tangent to the  $y_1$ - $y_2$  plane at the origin, and which may be written in the form:

$$w(y_1, y_2)(\theta) = m_1(\theta)y_1^2 + m_2(\theta)y_1y_2 + m_3(\theta)y_2^2 \tag{582}$$

The procedure is to substitute (582) into the equations of motion, collect terms, and solve for the unknown functions  $m_i(\theta)$ . Then the resulting expression is to be substituted into the  $y_1$ - $y_2$  equations (579). Note that if this is done for the example of eq.(510), i.e. for eqs.(581), the contribution made by  $w$  will be of degree 4 and higher in the  $y_i$ . However, stability of the origin will be determined by terms of degree 2 and 3, according to the following formula (obtainable by averaging). Suppose the  $y_1$ - $y_2$  equations are of the form:

$$\dot{y}_1 = \omega y_2 + h(y_1, y_2) \quad \text{and} \quad \dot{y}_2 = -\omega y_1 + g(y_1, y_2) \tag{583}$$



Then the stability of the origin is determined by the sign of the quantity  $Q$ , where

$$16Q = h_{111} + h_{122} + g_{112} + g_{222} - \frac{1}{\omega} [h_{12}(h_{11} + h_{22}) - g_{12}(g_{11} + g_{22}) - h_{11}g_{11} + h_{22}g_{22}] \quad (584)$$

where subscripts represent partial derivatives, which are to be evaluated at  $y_1=y_2=0$ .  $Q > 0$  means unstable,  $Q < 0$  means stable. See Guckenheimer and Holmes, *Nonlinear Oscillations, Dynamical Systems and Bifurcations of Vector Fields*, pp.154-156, where it is shown that the flow on the  $y_1$ - $y_2$  plane in the neighborhood of the origin can be approximately written in polar coordinates as:

$$\frac{dr}{dt} = Qr^3 + O(r^5) \quad (585)$$

Applying this criterion to eqs.(581) (in which  $w$  is assumed to be of the form (582) and hence contributes terms of higher order in  $y_i$ ), we find:

$$Q = -\frac{48}{(\pi^2 + 4)^2} = -0.2495 \quad (586)$$

The origin in eq.(510) for  $T=T_{cr}=\pi/2$  is therefore predicted to be stable. This result is in agreement with numerical integration, see Figure.

Now let's change the example a little so that  $w$  plays a significant role in determining the stability of the origin:

$$\frac{dx(t)}{dt} = -x(t - T) - x(t)^2 \quad (587)$$

Since the linear parts of this example and of the previous example are the same, our previously derived expressions for  $s_1$ ,  $s_2$ ,  $n_1$  and  $n_2$ , eqs.(570)-(573), still apply. Eqs.(581) now become:

$$\dot{y}_1 = y_2 - \left( \frac{8y_1}{\pi^2 + 4} - \frac{4\pi y_2}{\pi^2 + 4} + w(\theta = 0) \right)^2 \quad \text{and} \quad \dot{y}_2 = -y_1 \quad (588)$$

So our goal now is to find the functions  $m_i(\theta)$  in the expression for the center manifold (582), and then to substitute the result into eq.(588) and use the formula (584) to determine stability.

We begin by differentiating the expression for the center manifold (582) with respect to  $t$ :

$$\frac{\partial w(y_1, y_2)(\theta)}{\partial t} = 2m_1(\theta)y_1\dot{y}_1 + m_2(\theta)(y_1\dot{y}_2 + y_2\dot{y}_1) + 2m_3(\theta)y_2\dot{y}_2 \quad (589)$$

We substitute the equations (579) on  $\dot{y}_1$  and  $\dot{y}_2$  in (589) and neglect terms of degree higher than 2 in the  $y_i$ :

$$\frac{\partial w(y_1, y_2)(\theta)}{\partial t} = 2m_1(\theta)y_1\omega y_2 + m_2(\theta)(-y_1\omega y_1 + y_2\omega y_2) - 2m_3(\theta)y_2\omega y_1 + \dots \quad (590)$$

$$= \omega[-m_2(\theta)y_1^2 + 2(m_1(\theta) - m_3(\theta))y_1y_2 + m_2(\theta)y_2^2] + \dots \quad (591)$$

We obtain conditions on the functions  $m_i(\theta)$  by deriving another expression for  $\dot{w}$  and equating them. Let us differentiate eq.(552) with respect to  $t$ :

$$\frac{\partial x_t(\theta)}{\partial t} = \dot{y}_1(t)s_1(\theta) + \dot{y}_2(t)s_2(\theta) + \frac{\partial w(t)(\theta)}{\partial t} \quad (592)$$

$dx/dt = -x(t-T) - x^3$  for  $T = \pi/2$  with i.c.  $x = 0.1$  on  $[-T, 0]$

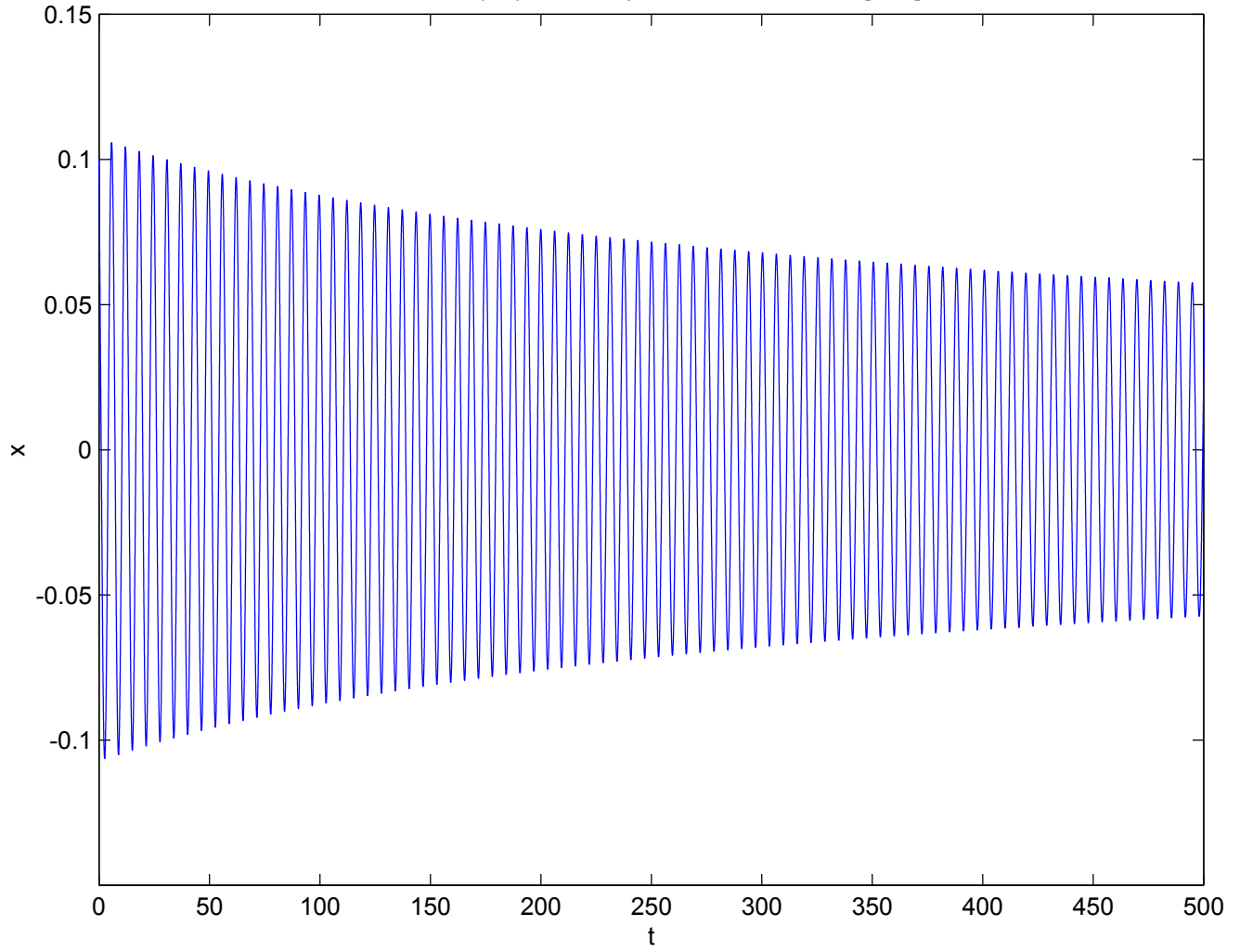

Using the functional DE (538)-(540), and rearranging terms, we get:

$$\frac{\partial w(t)(\theta)}{\partial t} = \frac{\partial x_t(\theta)}{\partial t} - \dot{y}_1(t)s_1(\theta) - \dot{y}_2(t)s_2(\theta) \tag{593}$$

$$= Ax_t(\theta) + Fx_t(\theta) - \dot{y}_1(t)s_1(\theta) - \dot{y}_2(t)s_2(\theta) \tag{594}$$

$$= A(y_1(t)s_1(\theta) + y_2(t)s_2(\theta) + w(t)(\theta)) + Fx_t(\theta) - \dot{y}_1(t)s_1(\theta) - \dot{y}_2(t)s_2(\theta) \tag{595}$$

$$= y_1As_1 + y_2As_2 + Aw + Fx_t - \dot{y}_1s_1 - \dot{y}_2s_2 \tag{596}$$

$$= y_1(-\omega s_2) + y_2(\omega s_1) + Aw + Fx_t - (\omega y_2 + (n_1, Fx_t))s_1 - (-\omega y_1 + (n_2, Fx_t))s_2 \tag{597}$$

$$= Aw + Fx_t - (n_1, Fx_t)s_1 - (n_2, Fx_t)s_2 \tag{598}$$

where we have used eqs.(542)-(543) and (579), and where the quantities  $(n_i, Fx_t)$  are given by eq.(580).

Eq.(598) is an equation for the time evolution of  $w$ . Since the operator  $A$  is defined differently for  $\theta \in [-T, 0)$  and for  $\theta = 0$ , we consider each of these cases separately when we substitute eq.(582) for the center manifold. In the  $\theta \in [-T, 0)$  case, eq.(598) becomes:

$$\frac{\partial w(t)(\theta)}{\partial t} = m'_1y_1^2 + m'_2y_1y_2 + m'_3y_2^2 - (n_1, Fx_t)s_1(\theta) - (n_2, Fx_t)s_2(\theta) \tag{599}$$

where primes denote differentiation with respect to  $\theta$ .

In the  $\theta=0$  case, eq.(598) becomes:

$$\begin{aligned} \frac{\partial w(t)(\theta)}{\partial t} = & \alpha(m_1(0)y_1^2 + m_2(0)y_1y_2 + m_3(0)y_2^2) \\ & + \beta(m_1(-T)y_1^2 + m_2(-T)y_1y_2 + m_3(-T)y_2^2) \\ & + f(x_t)(0) - (n_1, Fx_t)s_1(0) - (n_2, Fx_t)s_2(0) \end{aligned} \tag{600}$$

Now we equate eqs.(599) and (600) to the previously derived expression for  $\dot{w}$ , eq.(591). Equating (599) to (591), we get:

$$\begin{aligned} & m'_1y_1^2 + m'_2y_1y_2 + m'_3y_2^2 \\ & - (n_1, Fx_t)s_1(\theta) - (n_2, Fx_t)s_2(\theta) = \\ & \omega[-m_2y_1^2 + 2(m_1 - m_3)y_1y_2 + m_2y_2^2] + \dots \end{aligned} \tag{601}$$

Equating (600) to (591), we get:

$$\begin{aligned}
 &\alpha(m_1(0)y_1^2 + m_2(0)y_1y_2 + m_3(0)y_2^2) \\
 &+ \beta(m_1(-T)y_1^2 + m_2(-T)y_1y_2 + m_3(-T)y_2^2) \\
 &+ f(x_t)(0) - (n_1, Fx_t)s_1(0) - (n_2, Fx_t)s_2(0) = \\
 &\omega[-m_2(0)y_1^2 + 2(m_1(0) - m_3(0))y_1y_2 + m_2(0)y_2^2] + \dots
 \end{aligned} \tag{602}$$

Now we equate coefficients of  $y_1^2$ ,  $y_1y_2$  and  $y_2^2$  in eqs.(601) and (602) and so obtain 3 first order ODE's on  $m_1$ ,  $m_2$  and  $m_3$  and 3 boundary conditions. From eq.(580), the nonlinear terms  $(n_i, Fx_t)$  become:

$$(n_i, Fx_t) = n_i(0)f(y_1s_1(0) + y_2s_2(0) + \dots) \tag{603}$$

Also

$$f(x_t)(0) = f(y_1s_1(0) + y_2s_2(0) + \dots) \tag{604}$$

In the case of the example system (587) we have  $\alpha=0$ ,  $\beta=-1$ ,  $\omega = 1$ ,  $T = \pi/2$ , and

$$f(y_1s_1(0) + y_2s_2(0)) = -(y_1s_1(0) + y_2s_2(0))^2 \tag{605}$$

For this example, eq.(601) becomes

$$\begin{aligned}
 m'_1y_1^2 + m'_2y_1y_2 + m'_3y_2^2 + (y_1s_1(0) + y_2s_2(0))^2s_1(\theta) = \\
 -m_2y_1^2 + 2(m_1 - m_3)y_1y_2 + m_2y_2^2
 \end{aligned} \tag{606}$$

which gives the following 3 ODE's on  $m_i(\theta)$ :

$$m'_1 + s_1(0)^2s_1(\theta) = -m_2 \tag{607}$$

$$m'_2 + 2s_1(0)s_2(0)s_1(\theta) = 2(m_1 - m_3) \tag{608}$$

$$m'_3 + s_2(0)^2s_1(\theta) = m_2 \tag{609}$$

For this example, eq.(602) becomes

$$\begin{aligned}
 &-(m_1(-\pi/2)y_1^2 + m_2(-\pi/2)y_1y_2 + m_3(-\pi/2)y_2^2) \\
 &-(y_1s_1(0) + y_2s_2(0))^2 + (y_1s_1(0) + y_2s_2(0))^2s_1(0) = \\
 &-m_2(0)y_1^2 + 2(m_1(0) - m_3(0))y_1y_2 + m_2(0)y_2^2
 \end{aligned} \tag{610}$$

which gives the following 3 boundary conditions on  $m_i(\theta)$ :

$$-m_1(-\pi/2) - s_1(0)^2 + s_1(0)^3 = -m_2(0) \tag{611}$$

$$-m_2(-\pi/2) - 2s_1(0)s_2(0) + 2s_1(0)^2s_2(0) = 2(m_1(0) - m_3(0)) \tag{612}$$

$$-m_3(-\pi/2) - s_2(0)^2 + s_2(0)^2s_1(0) = m_2(0) \tag{613}$$

So we have 3 linear ODE's (607)-(609) with 3 boundary conditions (611)-(613) for the  $m_i(\theta)$ . In these equations,  $s_1$  and  $s_2$  are given by eqs.(570)-(571). The solution of these equations is

algebraically complicated. I used a computer algebra system to obtain a closed form solution for the  $m_i(\theta)$ . For brevity, a numerical version of the center manifold is given below:

$$\begin{aligned} w = & (0.20216 \sin 2\theta + 0.16022 \cos 2\theta - 0.6953 \sin \theta + 0.39537 \cos \theta - 0.5768) y_1^2 \\ & + (0.32044 \sin 2\theta - 0.40432 \cos 2\theta + 0.09393 \sin \theta + 0.5034 \cos \theta) y_1 y_2 \\ & + (-0.20216 \sin 2\theta - 0.16022 \cos 2\theta + 0.0299 \sin \theta + 0.64984 \cos \theta - 0.5768) y_2^2 \end{aligned} \quad (614)$$

Next we substitute the algebraic version of eq.(614) into the  $y_1$ - $y_2$  eqs.(588) and use eq.(584) to compute the stability parameter  $Q$ :

$$Q = \frac{32 (9 - \pi)}{5 (\pi^2 + 4)^2} = 0.19491 > 0 \quad (615)$$

Thus the center manifold analysis predicts that origin of eq.(587) is unstable. This result is in agreement with numerical integration, see Figure.

$dx/dt = -x(t-T) - x^2$  for  $T = \pi/2$  with i.c.  $x = 0.04$  on  $[-T, 0]$

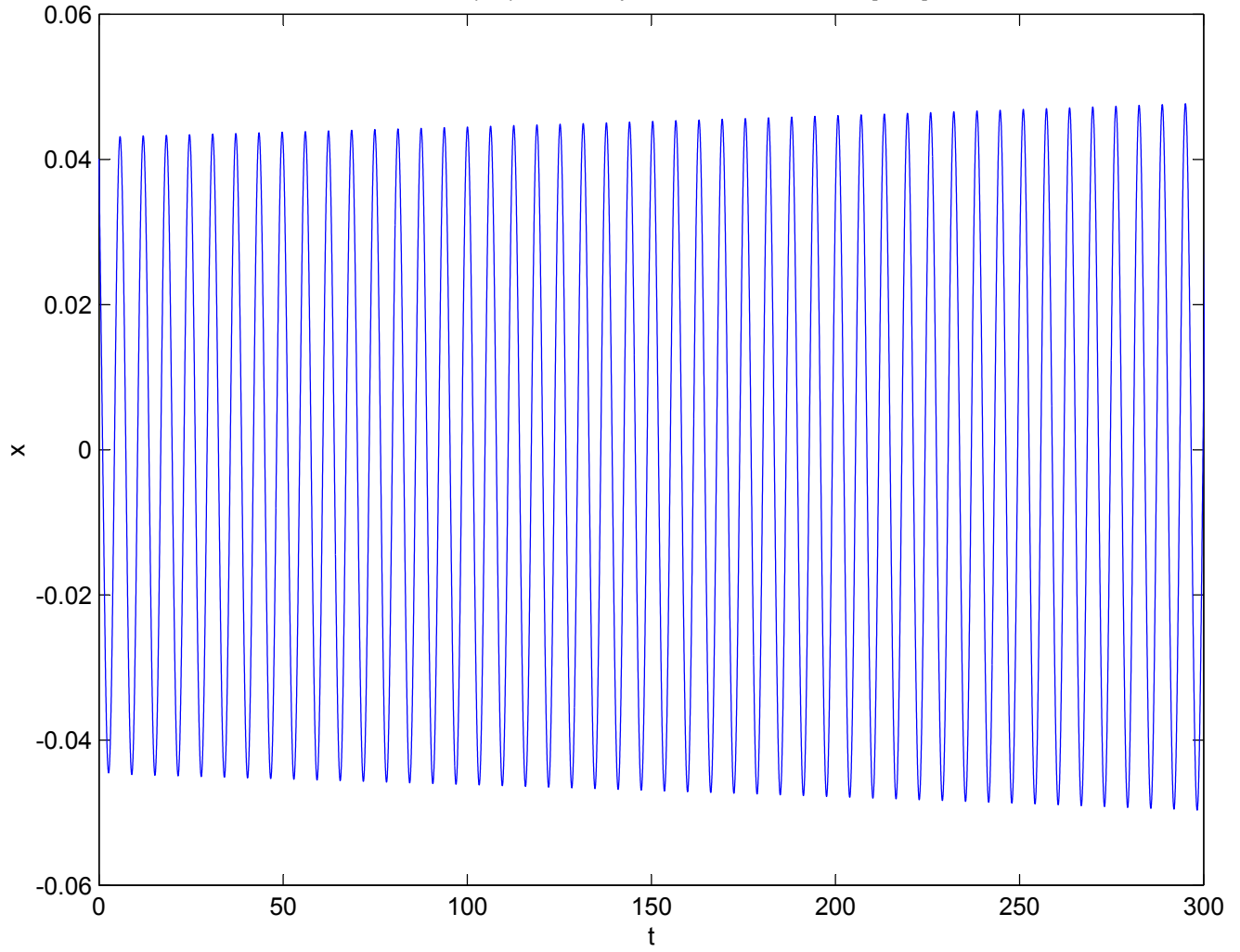

## 14.4 Problems

### Problem 14.1

For which values of the delay  $T > 0$  is the trivial solution in the following DDE stable?

$$\frac{dx(t)}{dt} = x(t) - 2x(t - T) \quad (616)$$

### Problem 14.2

Use Lindstedt's method to find an approximation for the amplitude of the limit cycle in the following DDE:

$$\frac{dx(t)}{dt} = -x(t - T) + x(t - T)^3 \quad (617)$$

### Problem 14.3

Use the center manifold approach to determine the stability of the  $x=0$  solution in the following DDE:

$$\frac{dx(t)}{dt} = -\frac{\pi}{2}x(t - 1)(1 + x(t)) \quad (618)$$

Here is an outline of the steps involved in this complicated calculation:

1. Show that the parameters of the linearized equation

$$\frac{dx(t)}{dt} = -\frac{\pi}{2}x(t - 1) \quad (619)$$

have been chosen so that the delay is set at its critical value for a Hopf bifurcation, i.e. the characteristic equation has a pair of pure imaginary roots,  $\lambda = \pm\omega i$ . Find  $\omega$ .

2. Find the eigenfunctions  $s_1(\theta)$ ,  $s_2(\theta)$  and the adjoint eigenfunctions  $n_1(\theta)$ ,  $n_2(\theta)$ . These are given by eqs.(548),(549),(563),(564), where the constants  $c_i$ ,  $d_i$  are related by the orthonormality conditions (558), in which the bilinear form  $(v, u)$  is given by eq.(553).

3. By comparing eq.(618) with the general form (536), identify  $\alpha$ ,  $\beta$ , and  $f$  for this system. This will permit you to write down eqs.(601) and (602), in which  $(n_i, Fx_t)$  and  $f(x_t)(0)$  are given by eqs.(603) and (604).

4. Equate coefficients of  $y_1^2$ ,  $y_1y_2$  and  $y_2^2$  in eqs.(601) and (602) and so obtain 3 first order linear ODE's on  $m_1(\theta)$ ,  $m_2(\theta)$  and  $m_3(\theta)$ , together with 3 boundary conditions.

5. Solve these for  $m_i(\theta)$ .

6. Substitute the resulting expressions for  $m_i(\theta)$  into eq.(582) for the center manifold.

7. Set  $\theta=0$  in your expression for the center manifold and substitute the result into the  $y_1$ - $y_2$  eqs.(579).

8. Compute  $Q$  from eq.(584).

Answer:  $Q = -\frac{4\pi}{5} \frac{(3\pi-2)}{(\pi^2+4)^2}$